



February 19, 2025

Mrs. Carrie Barefoot
Director OPC-EPD 401 Stormwater Branch
Office of Pollution Control, Mississippi Department of Environmental Quality
PO Box 2261, Jackson, MS 39225

RE: NOI
D Rock Mining, LLC.
D Rock Mining, LLC. Pit No. 1
Highway 84, Adams County, MS

Mrs. Barefoot,

On behalf of D Rock Mining, LLC. FC&E Engineering, LLC (FC&E) is submitting the enclosed surface mining permit application for the D Rock Mining, LLC. Pit No 1 surface mine in Adams County, MS. The application includes the following required documents:

Notice of Intent & SWPPP with figures.

In addition to the Mining Notice of Intent and Storm Water Pollution Prevention Plan a Surface Mine Application has been submitted to the Office of Geology. If you have any questions or require additional information, then please do not hesitate to contact me by phone at (601)517-6748 or by email at dsanford@fce-engineering.com.

Sincerely,
FC&E Engineering, LLC

A handwritten signature in black ink, appearing to read "David Sanford", is written over the typed name.

David Sanford, Manager.

RECEIVED

FEB 19 2025

AI: 86429

MSR323074



MISSISSIPPI DEPARTMENT OF ENVIRONMENTAL QUALITY

**MINING NOTICE OF INTENT (MNOI)
FOR COVERAGE UNDER
MINING STORM WATER, DEWATERING AND NO DISCHARGE
GENERAL PERMIT MSR323074
(Number to be assigned by State)**

File at least 30 days prior to the commencement of mining; 15 days if a Storm Water Pollution Prevention Plan (SWPPP) is already on file and mine dewatering is not proposed. Lateral expansion of an existing mine that has general permit coverage requires the submittal of the Major Modification Form, not a new MNOI. However, modification of the existing SWPPP to include the expansion is required. Discharge of storm water or impounded water associated with mining or the operation of a wastewater recirculation system with no discharge without written notification of coverage from MDEQ is a violation of State Law.

If the company seeking coverage is a corporation, a limited liability company, a partnership, or a business trust, attach proof of its registration with the Mississippi Secretary of State and/or its Certificate of Good Standing. This registration or Certificate of Good Standing must be dated within twelve (12) months of the date of the submittal of this coverage form. Coverage will be issued in the company name as it is registered with the Mississippi Secretary of State.

Please indicate the activities to be covered by this MNOI (check all that apply).

- Storm Water Discharges Associated with Mining Mine Dewatering
 Wastewater Recirculation System with No Discharge

The appropriate section of the MNOI must be completed if the applicant proposes to discharge storm water, discharge impounded mine water (dewatering) and/or operate a wastewater recirculation system with no discharge.

A site-specific Storm Water Pollution Prevention Plan (SWPPP) developed in accordance with ACT5 of the General Permit and a United States Geological Survey (USGS) quadrangle map or photocopy, indicating the site location and outfalls must be included with the MNOI submittal. The name of the quadrangle map must be shown on all copies. Quadrangle maps can be obtained from the MDEQ, Office of Geology at 601-961-5523. Additional submittals may include the following (check all that apply).

- Section 404 Documentation Notice of Exempt Operations Form
 Dam/Reservoir Safety Permit or Written Authorization

ALL INFORMATION MUST BE COMPLETED (indicate "N/A" where not applicable)

O.C

MSR32 MSR323074

(NUMBER TO BE ASSIGNED BY STATE)

APPLICANT IS THE: OWNER OPERATOR

OWNER CONTACT INFORMATION

OWNER CONTACT PERSON: Dray Stewart
OWNER COMPANY LEGAL NAME: WARCHEST HOLDINGS, LLC.
OWNER STREET OR P. O. BOX: 2129 London Dr. SW
OWNER CITY: Bogue Chitto STATE: MS ZIP: 39629
OWNER PHONE #: (601) 870-1191 OWNER EMAIL: draystewart21@gmail.com

OPERATOR CONTACT INFORMATION

OPERATOR CONTACT PERSON: DRAY STEWART
OPERATOR COMPANY LEGAL NAME: D ROCK MINING, LLC.
OPERATOR STREET OR P. O. BOX: 2129 LONDON DR.SW
OPERATOR CITY: BOGUE CHITTO STATE: MS ZIP: 39629
OPERATOR PHONE #: (601) 870-1191 OPERATOR EMAIL: draystewart21@gmail.com

MINE INFORMATION

MINE NAME: Warchest Holdings, LLC. Pit No.1
MINE SITE ADDRESS (If the physical address is not available, please indicate nearest named road.)
Street: Hwy 84
City: Natchez State: MS County: Adams Zip: 39120
SE &SW 1 /4 OF SE &SW 1 /4 OF SECTION 39, TOWNSHIP 7N, RANGE 1W
MINE SITE TRIBAL LAND ID (N/A If not applicable): N/A
ATTACH A USGS QUAD MAP, EXTENDING 1/2 MILE BEYOND FACILITY, OUTLINING THE MINE BOUNDARIES
(Maps can be obtained from the Mississippi Office of Geology. For information call 601-961-5523).
LATITUDE: 31 degrees 33 minutes 40 seconds LONGITUDE: 91 degrees 15 minutes 07 seconds
LAT & LONG DATA SOURCE (GPS (Please GPS Entrance Gate) or Map Interpolation): MAP
TOTAL ACREAGE: 13 MATERIAL TO BE MINED: FILL DIRT/CLAY GRAVEL
WILL HYDRAULIC DREDGING BE USED? YES NO
WASHING OF SAND/GRAVEL? YES NO

ESTIMATED START DATE: 2024 02 20
 YYYY-MM-DD
SIC CODE 1499

ESTIMATED END DATE: 2029 02 20
 YYYY-MM-DD
NAICS CODE 212319

RECEIVING STREAM INFORMATION

NEAREST NAMED RECEIVING STREAM: ST. CATHERINE CREEK

IS RECEIVING STREAM ON MISSISSIPPI'S 303(D) LIST OF IMPAIRED WATER BODIES? (The 303(d) list of impaired waters and TMDL stream segments may be found of MDEQ's website: http://www.deq.state.ms.us/MDEQ.nsf/page/TWB_Total_Maximum_Daily_Load_Section) YES NO

HAS A TMDL BEEN ESTABLISHED FOR THE RECEIVING STREAM SEGMENT? YES NO

COMPLETE IF STORM WATER DISCHARGE IS PROPOSED

ATTACH A STORM WATER POLLUTION PREVENTION PLAN (SEE PERMIT FOR REQUIREMENTS)

IDENTIFY THE ASSOCIATION OR GENERIC SWPPP ON FILE AT MDEQ: _____

COMPLETE IF WASTEWATER RECIRCULATION SYSTEM WITH NO DISCHARGE IS PROPOSED

DISTANCE BETWEEN RECIRCULATION POND(S) AND PROPERTY LINE: _____ (FT)
(MUST BE AT LEAST 150 FEET)

NUMBER OF RECIRCULATION POND(S): _____

STORAGE CAPACITY OF EACH RECIRCULATION POND(S): _____ (FT³)

COMPLETE IF MINE DEWATERING IS PROPOSED

ESTIMATED DEWATERING VOLUME: _____ (GAL/DAY)

NAME AND ADDRESS OF THE RECIPIENT OF THE DISCHARGE MONITORING REPORTS (DMRs), IF DIFFERENT FROM SIGNATORY: _____

DOCUMENTATION OF COMPLIANCE WITH OTHER REGULATIONS/REQUIREMENTS

Coverage under this general permit will not be granted until all other required MDEQ permits and approvals are addressed.

WILL THE CONSTRUCTION OR OPERATION OF THIS MINE INVOLVE THE RE-ROUTING, FILLING OR CROSSING OF A WATER CONVEYANCE OF ANY KIND? YES NO

If yes, contact the U.S. Army Corps of Engineers' Regulatory Branch for permitting requirements. If the mine requires a Corps of Engineers Section 404 permit, provide appropriate documentation with this MNOI that:

- The mine has been approved by individual permit, or
- The work will be covered by a nationwide permit and NO NOTIFICATION to the Corps is required, or
- The work will be covered by a nationwide or general permit and NOTIFICATION to the Corps is required.

LIST ANY NPDES PERMIT NO(s). _____ GEOLOGY APPLICATION/PERMIT NO. _____

LIST OTHER GEOLOGY PERMIT NUMBERS THAT APPLY TO COVERAGE AREA _____

IS THE MINE LESS THAN 4 ACRES AND GREATER THAN 1320 FEET FROM ANOTHER MINE?

- YES A "Notice of Exempt Operations" Form must be included with the MNOI or proof of prior submission, if previously submitted to the Office of Geology.
- NO A "Notice of Intent to Mine Class I or Class II Materials" Form must be filed before coverage will be granted under the Mining General Permit. For information on Office of Geology requirements, call 601-961-5515.

LIST ANY LOCAL STORM WATER ORDINANCES WITH WHICH THE OPERATIONS MUST COMPLY AND SUBMIT ANY ASSOCIATED APPROVAL DOCUMENTATION. _____

IF IMPOUNDMENTS WILL BE CONSTRUCTED ABOVE NATURAL SURFACE ELEVATIONS, INDICATE WHICH, IF ANY, OF THE FOLLOWING APPLY.

- The impoundment will be constructed with a peripheral dam or levee 8 feet or greater in height, measured from the lowest elevation of its toe.
- The impoundment will have a maximum storage volume greater than 25 acre-feet.
- The impoundment will impound a watercourse with a continuous flow.
- The impoundment has the potential to threaten downstream lives or man-made structures.

If any of the impoundments meet any of the above criteria, the applicant will be required to obtain written authorization from MDEQ, Dam Safety Division before coverage will be granted under the Mining General Permit.

I certify under penalty of law that this document and all attachments were prepared under my direction or supervision in accordance with a system designed to assure that qualified personnel properly gathered and evaluated the information submitted. Based on my inquiry of the person or persons who manage the system, or those persons directly responsible for gathering the information, the information submitted is, to the best of my knowledge and belief, true, accurate and complete. I am aware that there are significant penalties for submitting false information, including the possibility of fine and imprisonment for knowing violations.

Authorized Signature¹

_____ Date

Dray Stewart
Printed Name

President
Title

¹This application shall be signed according to the General Permit, Act 15, T-4 as follows:

- For a corporation, by a responsible corporate officer.
- For a partnership, by a general partner.
- For a sole proprietorship, by the proprietor.
- For a municipal, state or other public facility, by either a principal executive officer, the mayor, or ranking elected official.
- Duly Authorized Representative

Please submit this form to: Chief, Environmental Permits Division
MDEQ, Office of Pollution Control
P.O. Box 2261
Jackson, Mississippi 39225



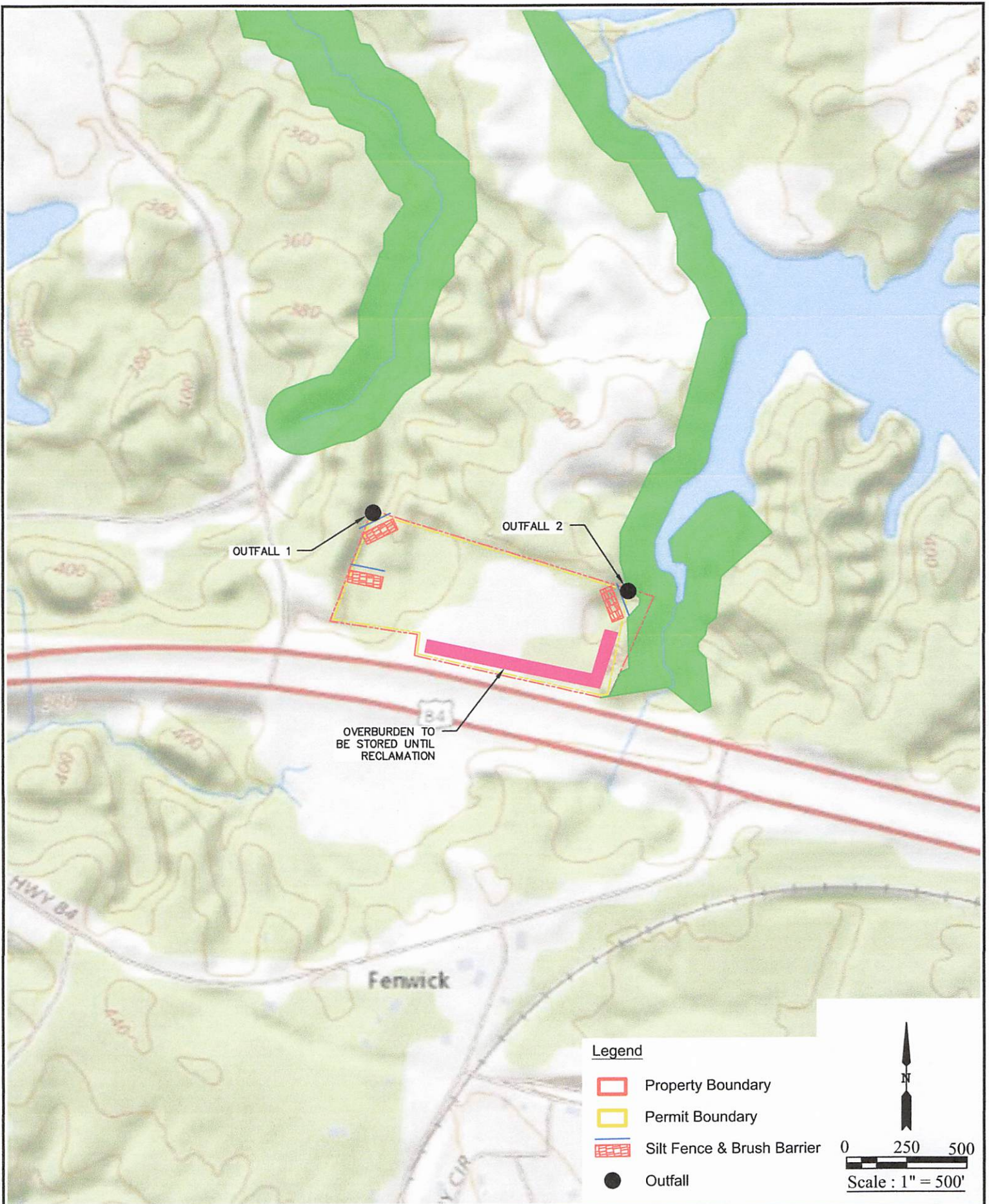

**MINING STORM WATER GENERAL PERMIT
STORM WATER POLLUTION PREVENTION PLAN
D ROCK Mining, LLC. Pit No. 1**

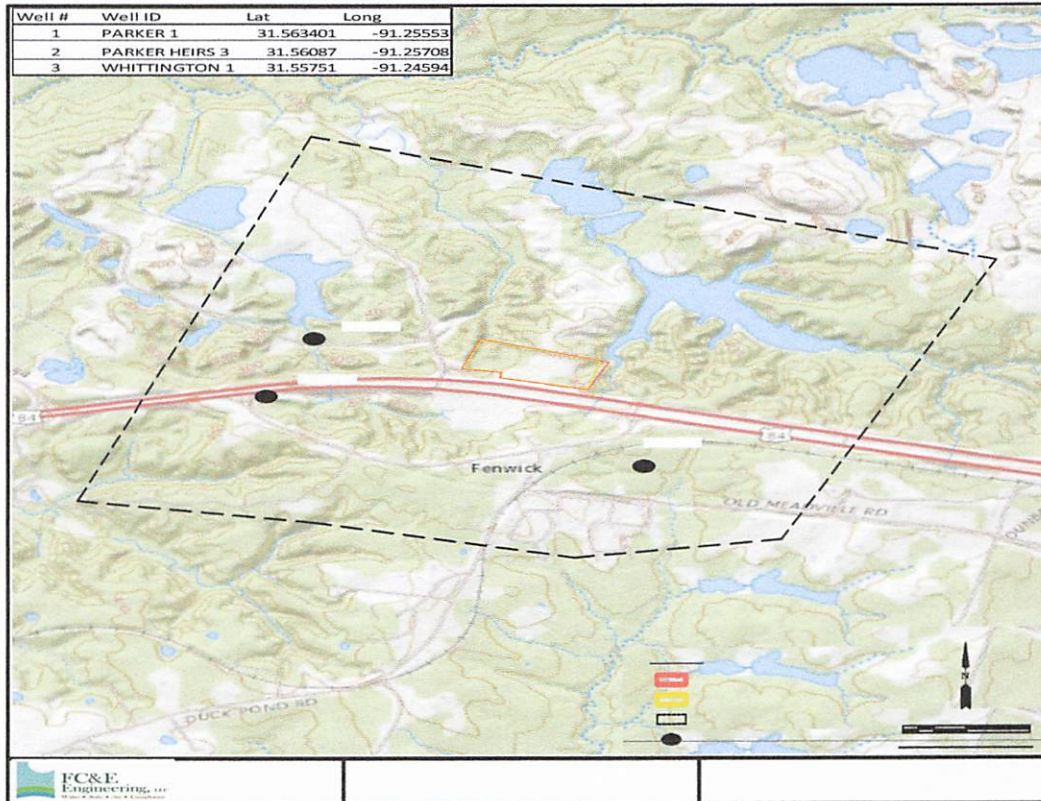

**D Rock Mining, LLC Pit No.1
Hwy.84 Site Adams, County, MS
December 2024**

Prepared by:



**917 Marquette Road
Brandon, MS 39042
(601) 824-1860**

TABLE OF CONTENTS

ABOUT THIS PLAN ii
SITE INFORMATION..... iv
CERTIFICATION..... iv
POLLUTION PREVENTION TEAM v
1.0 FACILITY INFORMATION.....1
1.1 SITE DESCRIPTION AND ACTIVITIES..... 1
1.2 FACILITY DRAINAGE 1
2.0 INVENTORY OF EXPOSED MATERIALS.....2
3.0 SIGNIFICANT SPILLS AND LEAKS2
4.0 EROSION AND SEDIMENT CONTROLS2
4.1 VEGETATIVE PRACTICES..... 4
4.2 STRUCTURAL PRACTICES..... 4
5.0 NON-STORM WATER DISCHARGES5
6.0 IMPLEMENTATION OF CONTROLS6
7.0 BEST MANAGEMENT PRACTICES7
7.1 GOOD HOUSEKEEPING MEASURES AND CONTROLS.....8
7.2 PREVENTIVE MAINTENANCE AND INSPECTION.....10
7.3 SPILL PREVENTION AND RESPONSE PROCEDURES.....10
7.4 EMPLOYEE TRAINING112
8.0 MONTHLY SITE INSPECTIONS AND EVALUATIONS..... 134
9.0 RECORDS RETENTION..... 15
10.0 TERMINATION OF PERMIT COVERAGE..... 155

WORKSHEET 1: MATERIALS EXPOSED TO STORM WATER

WORKSHEET 2: LIST OF SIGNIFICANT SPILLS AND LEAKS

WORKSHEET 3: MONTHLY INSPECTION FORM

WORKSHEET 4: ANNUAL INSPECTION REPORT FORM

WORKSHEET 5: NOTICE OF TERMINATION FORM

APPENDIX A

NOTICE OF INTENT

MINING STORM WATER, DEWATERING, AND NO DISCHARGE GENERAL PERMIT

APPENDIX B

FIGURES AND EROSION CONTROL DRAWINGS

APPENDIX C

RECORDS OF MONTHLY INSPECTIONS

APPENDIX D

RECORDS OF ANNUAL TRAINING

APPENDIX E

RECORDS OF SIGNIFICANT SPILLS AND LEAKS & NOTIFICATIONS TO AGENCIES

ABOUT THIS PLAN

This Storm Water Pollution Prevention Plan (SWPPP) was prepared by FC&E Engineering, LLC (FC&E) to help your facility comply with the Mining Storm Water, Dewatering, and No Discharge General Permit for Surface Mining Activities issued by the Mississippi Department of Environmental Quality (MDEQ). The permit requires you to prepare a SWPPP. This Plan has been prepared with the intent of meeting the SWPPP requirements.

The intent of the Plan is to minimize storm water pollution from your facility during mining activities associated with your facility. The Plan specifies the procedures your staff will follow and the engineering controls your facility will implement to prevent or minimize storm water from coming in contact with potential pollutants, or to contain storm water that does come in contact with potential pollutants. Your permit requires that you comply with this Plan. Items that need your immediate attention include:

1. Coverage under the Mining Storm Water, Dewatering, and No Discharge General Permit is authorized by the MDEQ for mining storm water and dewatering discharges and operation of wastewater recirculation systems with no discharge. **The updated SWPPP and the Notice of Intent should be submitted to the Environmental Permits Division of the MDEQ.**
2. The completed SWPPP is to be kept on site and utilized by you to ensure that storm water leaving the site is uncontaminated. A copy of the permit and the Notice of Intent are included in **Appendix A**. This SWPPP has been written in consideration of the requirements of this general permit.
3. **Section 8.0** of this Plan describes the Monthly Site Inspections that must be conducted by the Site Manager (or someone designated by the Site Manager). This section also describes the required information to be included on the inspection form. **Worksheet 3** contains the required Inspection and Certification Form for mining activities requiring erosion and sediment controls. Completed inspections using **Worksheet 3** should be stored in **Appendix C**. In addition, the Annual Storm Water Site Inspection Report Form must be submitted to MDEQ by January 28th for the previous calendar year.

4. Based on the results of each inspection, the control measures and practices will be revised (if appropriate) immediately following the inspection or prior to additional mining activity taking place. In addition, if the inspection report lists changes at the facility that have a significant effect on the potential for the discharge of pollutants to surface waters, the SWPPP will be amended.
5. A copy of MDEQ's *Handbook for Erosion Control, Sediment Control and Stormwater Management on Construction Sites and Urban Areas; Volume 1; Erosion and Sediment Control Practices* can be accessed on the internet via the following link for reference and use.

http://opcgis.deq.state.ms.us/Erosion_Stormwater_Manual_2ndEd/Volume1/Volume_1.pdf

Specific BMPs referenced herein are based on the guidelines of this handbook.

6. Within 30 days of final reclamation and completion of the project, a **completed Notice of Termination (NOT) form, Worksheet 5, must be submitted for the termination of permit coverage.** Upon receiving the completed NOT form, the MDEQ staff will inspect the site. If no sediment and erosion control problems are identified and adequate permanent controls are established, the owner or operator will receive a termination letter. Coverage is not terminated until done so in writing.

D Rock Mining, LLC. Pit No 1 – SWPPP
Hwy 84 Mine

SITE INFORMATION

Name and Address of the Site:

D Rock Mining, LLC. Pit No.1 Hwy 84 MINE

Hwy. 84, Section 39, T 7 N – R 1 W

Natchez, MS Telephone No.: (601) 870-1191

County: Adams Facility Contact: Dray Stewart

Latitude: 31° 33' 40.8341" N Longitude: 90° 15' 07.2551" W

Drainage Basin: TRIBUTARY OF St. CATHERINE CREEK

Name and Address of the Owner/Operator:

D Rock Mining, LLC

2129 London Dr SW

Bogue Chitto, MS 39629 Telephone No.: (601) 870-1191

CERTIFICATION

I certify under the penalty of the law that this document and all attachments were prepared under my direction or supervision in accordance with a system designed to assure that qualified personnel properly gathered and evaluated the information submitted. Based on my inquiry of the person or persons who manage the system, or those persons directly responsible for gathering the information, the information submitted is, to the best of my knowledge and belief, true, accurate, and complete. I am aware that there are significant penalties for submitting false information, including the possibility of fines and imprisonment for knowing violations.

Name: DRAY STEWART

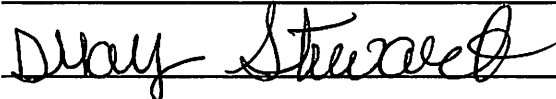
Signature: 

Title: PRESIDENT

Certification Date: 12/17/24

POLLUTION PREVENTION TEAM

Name: Dray Stewart, Mine Supervisor

Phone: (601) 870-1191

Responsibilities: Mr. Stewart is responsible for storm water pollution prevention activities at the facility. His role as leader of the Pollution Prevention Team includes the following responsibilities:

- (a) Updating the SWPPP as required
- (b) Performing monthly inspections of the facility
- (c) Ensuring that storm water pollution prevention is included in employee training classes
- (d) Supervising spill and leak cleanup
- (e) Supervising facility and procedural changes identified to minimize pollutant exposure to storm water
- (f) Communicating with regulatory agencies as needed

Name & Title: Dray Stewart, President

Phone: 601-870-1191

Responsibilities: Mr. Stewart is the responsible official for the facility. He is responsible for supporting the storm water management team by providing adequate resources to complete the activities identified in the SWPPP. He is also required to sign legal certification as identified in the SWPPP.

1.0 FACILITY INFORMATION

1.1 Site Description and Activities

The D Rock Mining, LLC. Pit No.1 Hwy 84 Mining Pit is a 13.20 acre surface mine operated by D Rock Mining, LLC. The surface mine is located in Section 39, Township 7 North – Range 1 West, Adams County, MS. The surface mine is accessed via HWY 84 in Adams County, MS. The primary purpose of the surface mine is the removal and transport of fill dirt and clay gravel. This is an existing mine. All surface mining is to be conducted by excavation. Brush barriers and silt fence will be installed prior to land disturbing activities. No dredging will be conducted. In addition, no washing operations will be held at the site. The primary Standard Industrial Classification (SIC) Code for the operation is 1499.

The USGS Quad Map, showing the property and permit boundary on a USGS Quadrangle Map, is included as **Figure 1**. The Site Layout Map, showing the features of the property and mining permit area, is included as **Figure 2**. There are no wetlands or hydric soils on this mine site. **Figure 3**. All figures are within **Appendix B**.

The mailing address for the operation is:

2129 London Dr. SW

Bogue Chitto, MS 39629

1.2 Facility Drainage

Storm water contacting the surface mine generally flows to the northeast and to the northwest and into a tributary of ST. Catherine Creek. This will be an incised pit; storm water will be directed to the northeast and to the northwest water will exit the mine site at two locations, outfall no 1 & 2, a rock berm with silt fence will be in place to filter the discharge. Drainage and general storm water flow can be seen in **Figures 2 & 3**. The existing pre-mining contours are shown in **Figure 5**, while the final contours upon completion of mining activities are shown on

Figure 6. The drainage areas and general storm water flow direction during and after mining operations are expected to be similar.

2.0 INVENTORY OF EXPOSED MATERIALS

Worksheet 1 contains a detailed inventory of materials used, stored, or produced onsite that are exposed to storm water.

3.0 SIGNIFICANT SPILLS AND LEAKS

There have been no significant spills or leaks exposed to storm water over the last three (3) years. **Worksheet 2** is included so the facility will have a ready mechanism to record information on any spill exposed to storm water that may occur during the period of the permit. Completed **Worksheet 2's** will be stored in **Appendix E**.

4.0 EROSION AND SEDIMENT CONTROLS

During ongoing mining operations, the ground will be disturbed and exposed. As such, the opportunity for storm water to be impacted by sediment runoff is likely unless measures are incorporated and implemented to ensure proper sediment control is in place. Site specific controls appropriate for the activities will be implemented by D Rock Mining, LLC. and are identified on the BMP Map (**Figure 4**), and Erosion Control Drawings in **Appendix B**. D Rock Mining, LLC. will control sediment erosion during the mining activities. The planned control activities include:

A. Silt fencing and/or straw wattles will be installed as needed downgradient from disturbed areas to control sediment resulting from initial site clearing as well as mining activities. If necessary, straw wattles will be staked in critical areas to reinforce the silt fencing. Silt fencing should be routinely inspected for proper installation and operation. Once sediment builds up to approximately one third to one half of the height of silt fencing, then sediment should be removed, and silt fencing replaced as needed.

D Rock Mining, LLC. Pit No 1 – SWPPP
Hwy 84 Mine

B. After the mining is complete, all exposed areas will be seeded with grass and/or mulched. When a disturbed area not being actively mined will be left undisturbed for 30 days or more, the appropriate temporary or permanent vegetative practices shall be implemented within seven (7) calendar days.

C. Activities will be controlled and monitored to minimize the impact of heavy equipment which will be operating in the area during mining. Any temporary fuel tanks or other bulk liquids will be stored in a diked area to control spillage. D Rock Mining, LLC. will advise its employees/contractors to perform any equipment maintenance in a manner that will not lead to spillage of fuel, oil, antifreeze, etc.

D. Rock check dams may be utilized as necessary at points of concentrated flow. Rock check dams should be routinely inspected for proper operation and capacity. Once sediment builds up to approximately one half of the height of check dams, then sediment should be removed.

E. The new excavation areas will be mined in a way to divert storm water to the existing mine areas on the site to collect runoff from the surrounding drainage areas. Accumulated sediment shall be removed when the capacity has been reduced by 50%. All removed sediment deposits shall be properly controlled and disposed of.

At a minimum, the controls will be designed, installed and maintained to:

- Control storm water volume and velocity within the site to minimize soil erosion.
- Control storm water discharges, including both peak flow rates and total storm water volume, to minimize erosion at outlets and to minimize downstream channel and stream bank erosion.
- Minimize the amount of soil exposed during mining.
- Minimize the disturbance of steep slopes.
- Minimize the sediment discharges from the site.
- Provide and maintain natural buffers around surface waters.
- All wetlands will be avoided and will not be impacted by surface mining.

- Maintain a 25-foot buffer from ephemeral streams for surface mining.
- Maintain a 50-foot buffer from intermittent streams for surface mining.
- Maintain a 150-foot buffer from perennial streams for surface mining.
- Minimize soil compaction and, unless infeasible, preserve topsoil.
- Direct storm water to vegetated areas, silt fences, straw wattles, etc. to aid in filtration, infiltration, velocity reduction and diffusion of the discharge.
- Transport runoff down steep slopes through lined channels or piping.
- Minimize off-site vehicle tracking of sediments.

4.1 Vegetative Practices

All disturbed areas will be managed and re-vegetated as soon as practicable upon completion of regular mining activities. Where applicable, disturbed areas will be stabilized by temporary seeding, permanent seeding, mulching and/or maintaining vegetative buffer strips as each case dictates. When a disturbed area not being actively mined will be left undisturbed for 30 days or more, the appropriate temporary or permanent vegetative practices shall be implemented within seven (7) calendar days.

4.2 Structural Practices

Structural erosion control measures shall be implemented as needed. The structural practices shall divert flows from exposed soils, store flows or otherwise limit runoff from exposed areas. The structural methods will include:

- A. Silt fencing will be installed as needed downgradient from all disturbed areas to control sediment resulting from initial site clearing as well as mining activities. If necessary, straw bales will be staked in critical areas to reinforce the silt fencing.
- B. Activities will be controlled and monitored to minimize the impacts of heavy equipment which will be operating in the area during mining. Any temporary fuel tanks or other bulk liquids will be stored in a diked area to control spillage. D Rock Mining, LLC. will advise its

employees/contractors to perform any equipment maintenance in a manner that will not lead to spillage of fuel, oil, antifreeze, etc.

C. Non-functioning controls shall be repaired, replaced or supplemented with functional controls within 24 hours of discovery or as soon as field conditions allow. D Rock Mining, LLC. will also be required to remove any excessive buildup of sediment from each silt fence, straw wattle, dike, or sediment trap. Accumulated sediment shall be removed from structural controls when sediment deposits reach one-third the height of the control. All removed sediment deposits shall be properly disposed.

The controls will, to the extent practicable:

- Divert upslope surface water around disturbed areas by means of diversion dikes.
- Limit exposure of disturbed areas to the shortest practical time.
- Minimize the amount of disturbed area at any given time.
- Implement best management practices to mitigate adverse impacts from storm water runoff.
- Slow rainfall runoff velocities to prevent erosive flows.

5.0 NON-STORM WATER DISCHARGES

Provided they do not cause or contribute to a violation of water quality standards, the following are considered allowable non-storm water discharges from mining activities occurring on the D Rock Mining, LLC. Facility:

- Discharges from actual fire-fighting activities.
- Water used to control dust.
- Potable water sources including uncontaminated water line flushing.
- Pavement wash waters where spills or leaks of toxic or hazardous materials have not occurred (unless all spilled material has been removed) and where detergents are not used.

- Uncontaminated air conditioning or compressor condensate.
- Uncontaminated ground water or spring water.
- Uncontaminated excavation dewatering.
- Landscape irrigation.
- Water used to wash vehicles, wheel wash water and other wash waters where detergents are not used.

The above non-storm water discharges should be eliminated or reduced to the extent feasible and controlled with an appropriate best management practice (BMP). The existing and proposed BMPs are listed in **Worksheet 1**.

6.0 IMPLEMENTATION OF CONTROLS

Controls shall be placed to minimize off-site vehicle tracking of sediments. Controls shall be implemented as needed to prevent adverse impact to receiving streams. When work is not being performed in a disturbed area, appropriate temporary and/or vegetative and structural practices shall be initiated.

Erosion and sedimentation control measures may include, but are not limited to, surface roughening, temporary seeding, permanent seeding, mulching, sod stabilization, vegetative buffer strips, earth dikes, brush barriers, drainage swales, check dams, silt fences and rock outlet protection.

D Rock Mining, LLC. Shall:

- Implement the site-specific controls to effectively manage storm water for the area to be disturbed. A copy of the site-specific SWPPP must be retained on site.
- Implement the following pre-mining activities:
 - Delineate and clearly mark any areas such as steep slopes, highly erodible soils or other sensitive areas; and
 - Preserve native topsoil on the site to the extent feasible.

- Amend the SWPPP if notified at any time by the Executive Director of the MDEQ that the SWPPP does not meet the minimum requirements. Unless otherwise provided, the necessary changes will be made within fifteen (15) days. D Rock Mining, LLC. will certify in writing to the Executive Director that the necessary changes have been made.
- Amend the SWPPP whenever there is a change in design, mining, operation, or maintenance which may potentially affect the discharge of pollutants to waters of the State; or the SWPPP proves ineffective in controlling storm water pollutants.
- Install needed erosion controls even if they may be located in the way of subsequent activities.
- Install additional and/or alternative erosion and sediment controls when existing controls prove to be ineffective in preventing sediment from leaving the site.
- Comply with applicable State or local waste disposal, sanitary sewer or septic regulations; and provide a portable toilet on site.
- Erosion and sediment controls shall be maintained at all times. Accumulated sediment will be removed from structural controls when sediment deposits reach one-third the height of the control. All removed sediment deposits will be properly disposed of. Non-functioning controls shall be repaired, replaced or supplemented with functional controls within 24 hours of discovery or as soon as field conditions allow.

7.0 BEST MANAGEMENT PRACTICES

Best management practices (BMPs) are measures taken at the facility to prevent or mitigate water pollution from mining activities. BMPs are broad ranging and may include processes, procedures, human actions, or construction. BMPs are aimed at preventing contamination of storm water by mining activities and/or spills and similar environmental incidents by stressing the importance of management and employee awareness of potential spill situations.

The following subsections describe BMPs that are to be included in the facility's SWPPP. These BMPs follow the guidelines described in the MDEQ's *Handbook for Erosion Control, Sediment*

D Rock Mining, LLC. Pit No 1 – SWPPP
Hwy 84 Mine

Control and Storm Water Management on Construction Sites and Urban Areas; Volume 1; Erosion and Sediment Control Practices which can be accessed on the internet via the following link.

http://opcgis.deq.state.ms.us/Erosion_Stormwater_Manual_2ndEd/Volume1/Volume_1.pdf

7.1 Good Housekeeping Measures and Controls

Good housekeeping practices are designed to maintain a clean and orderly work environment and to prevent pollutants from entering storm water from mining sites. At this facility, the following types of good housekeeping measures should be implemented in an effort to prevent pollutants from entering storm water discharges.

Operation and Maintenance

- Garbage and waste materials are regularly picked up and properly disposed of.
- All spillage is promptly removed. Where it is impractical to constantly remove spillage, spillage is contained in the immediate area temporarily until further removal can take place.
- Equipment is routinely inspected to make sure it is in working order and no leaks are occurring.
- Provide and maintain a portable toilet for sanitary purposes.
- The importance of spill cleanup procedures is communicated to employees.

Material Storage Practices

- Provide protected storage areas for chemicals, paints, solvents, fertilizers, pesticides, herbicides, detergents, and other potentially toxic materials. Adequate aisle space should be provided to facilitate material transfer and easy access for inspections.
- Containers, drums, and bags of material should be stored away from direct traffic routes to prevent accidental spills.
- Containers should be stacked according to manufacturers' instructions.

D Rock Mining, LLC. Pit No 1 – SWPPP
Hwy 84 Mine

- Implement spill and leak prevention practices and response procedures if spills and leaks do occur.
- Minimize the exposure of building materials, building products, mining waste, trash, and landscape materials.
- As appropriate, containers should be stored on pallets to prevent corrosion.

Material Inventory Procedures

- An up-to-date inventory of hazardous and non-hazardous materials should be kept at the facility office.
- Containers are labeled with the name of the material, expiration date, and health hazards, as required.
- Storage areas with hazardous materials have been specifically designed to contain spills, as required.

Employee Participation

- Information on best management practices is discussed during employee training sessions.
- Good housekeeping measures are discussed at employee meetings.

Operation and Maintenance

- Designate and maintain areas for equipment maintenance and repair.
- Floors and ground surfaces should be kept clean by using brooms, shovels, or cleaning machines.
- Provide waste receptacles and regular collection of waste. Garbage, litter, and waste materials should be regularly picked up and properly disposed of.
- Remove all spillage promptly. Where it is impractical to constantly remove spillage, spillage should be contained in the immediate area temporarily until further removal can take place.
- Inspect equipment routinely to make sure it is in working order and no leaks are occurring.
- Communicate the importance of spill cleanup procedures to employees.

7.2 Preventive Maintenance and Inspection

The preventive maintenance and inspection program includes:

- Timely inspections and maintenance of storm water controls.
- Proper maintenance of facility equipment and systems.

7.3 Spill Prevention and Response Procedures

Limited amounts of oil and/or chemical products are anticipated to be stored onsite during mining activities but should be below the 1,320-gallon threshold requiring compliance with the SPCC regulations during mining. This SWPPP will address some spill prevention and response issues for the mining phase of this project. In the event of a spill, employees are instructed to make every effort to contain the release, notify the SWPPP Coordinator and prevent any release from leaving the facility site. It will be the SWPPP Coordinator's responsibility to determine if the spill needs to be reported to the regulatory authorities. Records of significant spills and leaks and notifications to the appropriate agencies will be stored in **Appendix E**.

Additional preventative measures utilized by the site are: 1) proper storage and disposal of used batteries; 2) proper labeling of drums containing used oil and ensuring that stored drums are kept inside buildings and away from potential accidental tippage situations; 3) maintaining accurate labels and inventories of chemical materials, solvents, paints, lubricants etc.; and 4) storage of solvents and flammable materials in a proper and safe manner.

Likely Releases and In-place Preventative Controls:

Spills and releases are most likely to result from potential equipment failure or operator error. This section summarizes potential causes of releases and associated in-place preventative controls.

1. Operator error during loading/unloading or refueling operations. Potential errors include overfilling, not disconnecting lines prior to vehicle departure, drain valves left open, or fill valves left open allowing precipitation to enter and cause tank overflow. Specific procedures have been developed to minimize this potential and include regular

periodic inspections, locking valves when not in use, and on-the-job training in correct procedures.

2. Piping, pressure fittings, tank ruptures, or other forms of equipment failure. The rate and quantity of a release would depend on the location of the rupture. Release rate could be assumed to be the total volume of the tank associated with the piping or fittings being released in a 15-minute timeframe. The release to the environment would be at that rate but the quantity would be the total volume minus the secondary containment volume. To minimize the potential for a significant release, regular inspections and maintenance are performed with noted problems addressed in a timely manner by repair, replacement, or equipment taken out of service.
3. Puncture of tank or associated piping by heavy equipment. Operators of equipment and vehicles must be well trained in operating large equipment on the facility. Rate and quantity to be released would be the same as that discussed in item 2. Additionally, tanks and piping are highly visible by size, signage, flagging, or protective paint color. In the event of night traffic, sufficient lighting is provided to make tanks and piping visible.
4. Small drips, leaks and spills from lines or valves. Release rates would be negligible and are not likely to produce significant quantities or environmental impacts. To minimize release quantities, equipment is inspected regularly, repaired in a timely manner when a problem is discovered, and corrective action implemented with released material promptly cleaned up. In general, this type of release presents a very low risk of potential impact.

7.4 Employee Training

D Rock Mining, LLC. will train employees on the elements of this plan. D Rock Mining, LLC. will periodically evaluate the effectiveness of the installed storm water pollution control measures. Following each periodic assessment, D Rock Mining, LLC. will evaluate the successes and failures of the storm water pollution control system at the site. Should an evaluation show additional

D Rock Mining, LLC. Pit No 1 – SWPPP
Hwy 84 Mine

measures are necessary to control runoff pollutants, D Rock Mining, LLC. will make additions of sediment control structures or other reasonable adjustments to this plan.

New employees receive initial training in storm water pollution prevention before they begin their work assignments at the mining site. Thereafter, training is provided, and storm water pollution prevention discussed as needed at the safety meetings that employees attend.

Training records should be maintained for at least three (3) years. Training records should include the employee's name, worker identification number, contents of training, and the employee's signature acknowledging that training was received.

The training program addresses four (4) major areas:

- Elements of the Storm Water Pollution Prevention Plan
- Spill prevention and response
- Good housekeeping
- Materials management practices

A brief description of each topic covered as part of the training program is outlined below.

Elements of the Storm Water Pollution Prevention Plan

Employees/contractors are instructed on each of the elements contained in this plan related to the management of storm water from mining activities.

Spill Prevention and Response

Limited amounts of oil and/or chemical products are expected to be stored onsite during mining. **Employees should be made aware to contact D Rock Mining, LLC'S SWPPP Coordinator in the event of a spill of oil or potentially hazardous chemicals.** Training involving spills are discussed briefly in Section 7.3 above and as follows:

- Employees involved in the storm water pollution prevention program are shown the potential spill areas and drainage routes at the facility.

D Rock Mining, LLC. Pit No 1 – SWPPP
Hwy 84 Mine

- Employees are given instructions on how to report spills and the appropriate individuals to contact.
- Proper material handling procedures and storage requirements are discussed.

Good Housekeeping

- Employees/contractors are instructed to perform regular vacuuming or sweeping in their work areas to prevent storm water from becoming contaminated with waste materials.
- Employees/contractors are instructed to promptly clean up spilled materials to prevent storm water from becoming contaminated.
- Locations of housekeeping and spill response equipment and supplies are provided to all employees. D Rock Mining, LLC. will be required to provide adequate housekeeping and spill response equipment to manage storm water for all areas under their supervision.
- Where appropriate, employees are provided with instructions on the proper methods to secure drums and other containers. Those working near containers/drums are also instructed to routinely check the integrity of the containers to make sure there are no leaks.

Materials Management Practices

- Employees/contractors are instructed to maintain materials in an organized manner.
- Toxic and hazardous substances onsite should be clearly marked.
- Proper and safe handling procedures are discussed with employees who are responsible for handling any toxic and/or hazardous substances.

8.0 MONTHLY SITE INSPECTIONS AND EVALUATIONS

Best management practices (BMPs) must be in place to control run-off. Inspection of all receiving streams, erosion, and sediment controls, and other SWPPP requirements shall be performed during permit coverage by qualified personnel. The SWPPP Site Manager or his designee will conduct a monthly site inspection and as often as necessary to ensure appropriate erosion and sediment controls have been properly constructed and maintained. Inspections

must also be conducted within 24 hours of a rainfall event equal to or greater than a 2-year, 24-hour storm event (approximately 5 inches). Non-functioning controls shall be repaired, replaced or supplemented with functional controls within 24 hours of discovery or as soon as field conditions allow. The purposes of the inspections are to:

1. Confirm the accuracy of the description of potential pollutant sources contained in the SWPPP.
2. Determine the effectiveness of the Plan and its BMPs for preventing storm water pollution due to mining activities.
3. Assess compliance with the terms and conditions of the General Permit and if necessary, implement new BMPs that will protect storm water runoff from polluting nearby streams.

During the evaluation, material handling and storage areas, mining activities, and other potential sources of pollution will be visually inspected for evidence of actual or potential pollutant discharges to the drainage system. Erosion controls and structural storm water management devices will also be inspected to ensure that each is operating correctly. **Worksheet 3** is provided to assist in the monthly inspections.

The results of each inspection will be documented on the form provided as **Worksheet 3** and signed by an authorized company official. The report will describe:

- Name and address of the person making the inspection.
- Date and time of the inspection; and
- Whether any deficiencies were noted. If deficiencies were noted, then list the corrective action taken.

Inspections must continue until the permit coverage has been terminated. Monthly inspection reports are to be stored in **Appendix C**. Based on the results of each inspection, the description of potential pollutant sources and measures and controls will be revised (if appropriate) immediately following the inspection or prior to additional mining activity taking place. In

D Rock Mining, LLC. Pit No 1 – SWPPP
Hwy 84 Mine

addition, if the inspection report lists changes at the facility that have a significant effect on the potential for the discharge of pollutants to surface waters, the SWPPP will be amended.

9.0 RECORDS RETENTION

All records, reports, forms, and information resulting from activities required by the General Permit shall be retained for a period of at least three (3) years from the date the document was generated.

10.0 TERMINATION OF PERMIT COVERAGE

A completed Request for Termination of Coverage From will only be submitted to the MDEQ Permit Board if all mining operations are ceased with no future plans to resume mining operations. Coverage is not terminated until notified in writing by MDEQ.

D Rock Mining, LLC. Pit No 1 – SWPPP
Hwy 84 Mine

WORKSHEET 1: MATERIALS EXPOSED TO STORM WATER

Worksheet 1: Materials Exposed to Storm Water

Material: Silt and soil from site groundwork.
Purpose: Mining activities
Location: Majority of the site.
Quantity Used: Varies **Produced:** N/A **Stored:** N/A
Quantity Exposed to Storm Water in Past 3 Years: N/A
Past Significant Spill or Leak Exposed to Storm Water: N/A
If "Yes", Describe:
Method of Storage or Disposal: N/A
Description of Material Management Practice: Best management practices used for clearing, site work and mining. Silt fences used to stabilize soil prone to erosion.

Material: Off-road diesel fuel, hydraulic oil, lubrication oil and motor oil.
Purpose: Fueling and maintenance of on-site heavy equipment.
Location: Throughout the mining area.
Quantity Used: Varies **Produced:** N/A **Stored:** Varies.
Quantity Exposed to Storm Water in Past 3 Years: N/A
Past Significant Spill or Leak Exposed to Storm Water: No
If "Yes", Describe:
Method of Storage or Disposal: Horizontal Steel Closed Top Tanks and 55-gallon steel drums
Description of Material Management Practice: Tanks are inspected routinely to ensure that no leaks are occurring; proper fueling techniques and training to ensure that overfilling and spills are minimized or avoided; proper cleanup and remediation as needed to cleanup spills before they can impact storm water. Secondary containment should be used for diesel/oil storage.

Material: Heavy equipment (tractors, track hoes, bulldozers, skidders, trucks, etc.)
Purpose: Mining operations.
Location: Throughout the proposed site location.
Quantity Used: Equipment used as needed **Produced:** N/A
Stored: On-site and used as needed
Quantity Exposed to Storm Water in Past 3 Years: N/A.
Past Significant Spill or Leak Exposed to Storm Water: No
If "Yes", Describe:
Method of Storage or Disposal: N/A
Description of Material Management Practice: Heavy equipment is inspected routinely to check for leaking hoses or other areas of potential oil or fuel leaks. Equipment is maintained in a manner to minimize the contamination of storm water. Required periodic preventive maintenance is performed on all heavy equipment.

D Rock Mining, LLC. Pit No 1 – SWPPP
Hwy 84 Mine

WORKSHEET 2: LIST OF SIGNIFICANT SPILLS AND LEAKS

D Rock Mining, LLC. Pit No 1 – SWPPP
 Hwy 84 Mine

Worksheet 2: List of Significant Spills and Leaks

D Rock Mining, LLC. Pit No.1 Hwy 84 Mine Site Adams County, MS				Completed by: Title: Date:						
Directions: Record below all significant spills and significant leaks of chemicals, petroleum products, or toxic / hazardous pollutants that occur at the facility. Maintain these records for 3 years after this permit has terminated.										
Definitions: Significant spills include, but are not limited to, releases of oil that cause sheen on waters of the United States (offsite ponds, creeks, rivers, etc.), or the release of a Reportable Quantity of any chemical. Consult MSDS sheet for spill cleanup and chemical information.										
Date (m/d/y)	Check One or Both		Location (as indicated on site map)	Description				Response Procedure		Preventive Measures Taken
	Spill	Leak		Type of Material	Quantity (Estimate)	Source	Reason	Amount of Material Recovered	Is Material Still Exposed to Storm Water? (Yes or No)	
Worksheet 2 is provided for use in recording future spills. This form should be completed promptly after a spill has occurred to document the event and to provide information for future training topics. It is recommended that a monthly notation of "No spills have occurred during Month XX" be placed in Worksheet 2 for any months in which no spills occur.										

D Rock Mining, LLC. Pit No 1 – SWPPP
Hwy 84 Mine

WORKSHEET 3: MONTHLY INSPECTION FORM

Monthly Inspection Checklist

Facility:		Inspector:		Date:		Page 1 of 2	
Item No.	Item	N/A	Y	N	Comments / Corrective Action(s) / Date of Corrective Action(s) Completion		
<p><i>Inspections. During coverage under this permit, all areas contributing to storm water discharges associated with industrial activity (including aboveground storage tanks, piping, containment/collection systems, truck wash down, and equipment cleaning areas) must be visually inspected as often as needed but no less than once monthly. The inspection must evaluate whether the SWPPP adequately minimizes pollutant loadings and is properly implemented in accordance with the terms of this permit or whether additional control measures are needed. This includes observing storm water discharges for obvious industrial storm water pollution such as color, lack of clarity, floating solids, settled solids, suspended solids, foam, and oil sheens. Description of corrective actions and date of when the corrective action is completed must be documented for all deficiencies noted during inspections.</i></p>							
SWPPP AREAS							
SW-1	Visual inspection. Are all potential areas contributing to storm water discharges associated with industrial activity identified?						
SW-2	Are aboveground storage tanks/maintenance area contributing to storm water pollution?						
SW-3	Is mobile machinery contributing to storm water pollution?						
SW-4	Are dry wood storage areas contributing to storm water pollution?						
SW-5	Is portable sawmill area contributing to storm water pollution?						
EROSION-PRONE AREAS							
ER-1	Are drainage pathways at the site free of evidence of soil erosion?						
ER-2	Are ditches and ponds onsite free of significant depths of sediment?						
ER-3	If sediment controls (for example, silt fences, rock rip rap, seeding, hay bales, etc.) are used onsite (check N/A if not), are they in good shape and operating properly?						
ER-4	Does all sediment remain onsite? If not, explain what erosion control measures could help prevent it from leaving the site.						
STORM WATER CONTROLS							
SW-1	Are inlets, pipes, ditches, and ponds (check N/A if none) free of excess sediment?						
SW-2	Are inlets, pipes, ditches, and ponds (check N/A if none) free of debris, raw materials, waste materials, oil sheen, and other possible contaminants?						
SW-3	If outfalls leaving property are flowing during dry weather (check N/A if none are flowing), is flow due to permitted non-storm water discharge? If not, describe source of flow (for example, groundwater, unpermitted non-storm water discharge, etc.).						
<p>FACILITY EQUIPMENT <i>Visual Site Inspection. Identified personnel shall at least monthly inspect facility equipment and material handling areas for evidence of pollutants entering the drainage system and verify the description of potential pollutant sources and the implementation of management controls. Establish tracking or follow-up procedures for appropriate inspection response.</i></p>							
FE-1	Is facility equipment polluting the drainage system?						
FE-2	Are material handling areas polluting the drainage system? If so, describe.						
FE-3	Do you see any equipment, materials, or conditions that could potentially pollute storm water runoff? If so, describe.						
FE-4	Observe the last monthly inspection report. Were deficient items or conditions identified in the last inspection report corrected? If not, correct deficiency or condition						
PETROLEUM PRODUCT STORAGE TANKS							
TS-1	Are tanks free of excess rust or other signs of compromised tank integrity?						
TS-2	Are all pumps, valves, hoses, piping, etc., intact and operating properly?						
TS-3	Are all pumps and valves closed and/or locked when not in use?						

Monthly Inspection Checklist (Continued)

Facility:		Inspector:		Date:		Page 2 of 2	
Item No.	Item	N/A	Y	N	Comments/Corrective Actions/Date of Corrective Action Completion		
DRUM & TOTE STORAGE AREAS							
DS-1	Are drums stored on pallets or racks above the ground surface?						
DS-2	Are all drums within a secondary containment system?						
DS-3	If some drums are not within secondary containment, are they fewer than 5 total and in active use in facility processes?						
DS-4	Are drums intact? If not, describe any leakage.						
DS-5	Are drums stacked or stored according to manufacturers' recommendations?						
DS-6	Are drums closed/sealed when not in use?						
DS-7	If secondary containment is used, then is the containment free of cracks, holes, or other breaches?						
DS-8	Are containment release valves closed and operating properly, if applicable?						
DS-9	Are storm water releases from the containment being properly documented, if applicable?						
DS-10	Is water in the containment (mark N/A if no water or no containment) free of any sheen?						
DS-11	Are the contents of each drum clearly labeled?						
BATTERY STORAGE AREA							
BS-1	Are batteries properly labeled including accumulation start date?						
BS-2	Are any batteries cracked/leaking?						
STORAGE AREAS EXPOSED TO STORM WATER							
SA-1	Are stored materials prevented from reaching inlets, pipes, ditches, or ponds?						
SA-2	Are storm water controls in good shape and operating properly? (for example, silt fences, hay bales, screens over inlets and culverts, etc.)						
LOADING/UNLOADING AREAS							
LU-1	Do previous spills in the areas appear to have been adequately addressed? If not, describe and list the outfalls that the areas drain to.						
LU-2	Is the area free of raw materials, waste materials, debris, and dust?						
LU-3	Are standard loading/unloading procedures prominently posted in the areas?						
LU-4	If there is a local drain (check N/A if none), is it free from obstructions?						
DRINKING WATER							
DW-1	Is the drinking water free of any unusual taste, odor, or color?						
SPILLS OCCURRED							
SO-1	Have any spills occurred?						
SO-2	Have spills been adequately addressed and recorded?						
Note: N/A = Not Applicable							

D Rock Mining, LLC. Pit No 1 – SWPPP
Hwy 84 Mine

WORKSHEET 4: ANNUAL INSPECTION REPORT FORM

**COVERAGE NUMBER (MSR32 _____) INSPECTION YEAR _____
 SITE INSPECTION REPORT AND CERTIFICATION FORM
 MINING GENERAL PERMIT**



Results of the inspection by ACT7 of this permit shall be recorded on this report form and in addition, copies of all completed forms shall be retained onsite or locally available. Inspections must be performed monthly and after a 2-year, 24-hour storm event (approx. 6-inches on Gulf Coast to 4-inches at MS/TN State Line). The coverage number must be listed at the top of all Site Inspection Report and Certification Forms.

COVERAGE RECIPIENT INFORMATION

COMPANY NAME: _____ MINE NAME: _____
 MINE LOCATION: _____ GEOLOGY APPLICATION/PERMIT NO. _____
 NEAREST PROJECT CITY: _____ COUNTY: _____
 MAILING ADDRESS: _____
 MAILING CITY: _____ STATE: _____ ZIP: _____
 CONTACT PERSON: _____ CONTACT PHONE NUMBER: _____

INSPECTION DOCUMENTATION

DATE (mm/dd/yy)	TIME (hh:mm AM/PM)	AFTER 2-YEAR, 24-HOUR STORM EVENT? (CHECK IF YES)	ANY DEFICIENCIES? (CHECK IF YES)	INSPECTOR(S)
		<input type="checkbox"/>	<input type="checkbox"/>	
		<input type="checkbox"/>	<input type="checkbox"/>	
		<input type="checkbox"/>	<input type="checkbox"/>	
		<input type="checkbox"/>	<input type="checkbox"/>	
		<input type="checkbox"/>	<input type="checkbox"/>	
		<input type="checkbox"/>	<input type="checkbox"/>	
		<input type="checkbox"/>	<input type="checkbox"/>	
		<input type="checkbox"/>	<input type="checkbox"/>	
		<input type="checkbox"/>	<input type="checkbox"/>	
		<input type="checkbox"/>	<input type="checkbox"/>	
		<input type="checkbox"/>	<input type="checkbox"/>	
		<input type="checkbox"/>	<input type="checkbox"/>	
		<input type="checkbox"/>	<input type="checkbox"/>	
		<input type="checkbox"/>	<input type="checkbox"/>	
		<input type="checkbox"/>	<input type="checkbox"/>	
		<input type="checkbox"/>	<input type="checkbox"/>	

Deficiencies Noted During any Inspection (give date(s); attach additional sheets if necessary): _____

Corrective Action Taken or Planned (give date(s); attach additional sheets if necessary): _____

Based upon this inspection which I or personnel under my direct supervision conducted, I certify that all erosion and sediment controls have been implemented and maintained, except for those deficiencies noted above, in accordance with the Storm Water Pollution Prevention Plan filed with the Office of Pollution Control and sound engineering practices as required by the above referenced permit. I further certify that the MNOI and SWPPP information on file with MDEQ is up to date.

I certify under penalty of law that this document and all attachments were prepared under my direction or supervision in accordance with a system designed to assure that qualified personnel properly gather and evaluate the information submitted. Based on my inquiry of the person or persons responsible for gathering the information, the information submitted is, to the best of my knowledge and belief, true, accurate and complete. I am aware that there are significant penalties for submitting false information, including the possibility of fines and imprisonment for knowing violations.

 Authorized Signature

 Date

 Printed Name

 Title

D Rock Mining, LLC. Pit No 1 – SWPPP
Hwy 84 Mine

WORKSHEET 5: NOTICE OF TERMINATION FORM

Request for Termination (RFT) of Coverage



Mining General NPDES Permit No. MSR32 _____ County _____
(Fill in your Certificate of Coverage Number and County)

Use this form to request coverage termination only after mining activities have permanently stopped and permanent erosion and sediment controls are successfully established. Inspections must continue until the coverage recipient receives written notice of coverage termination by MDEQ.

Please check which of the following apply:

- Non-Exempt Mining Operation (copy of Permit Board Order, authorizing 90% or final release of mining performance bond attached)
- Exempt Mining Operation (as defined in MDEQ's Mississippi Surface Mining and Reclamation Rules and Regulations)

(Please Print or Type)

Facility Name: _____ Closure Date: _____

Physical Site Street Address (if not available, indicate nearest named road): _____

City: _____ County: _____

Landowner Company Name: _____

Landowner Company Contact Name and Position: _____

Street Address / P.O. Box: _____

City: _____ State: _____ Zip: _____

Tel. # (_____) _____

Operator Company Name (if different than owner): _____

Operator Contact Name and Position: _____

Street/ Address / P.O. Box: _____

City: _____ State: _____ Zip: _____

Tel. # (_____) _____

I certify under penalty of law that this document and all attachments were prepared under my direction or supervision in accordance with a system designed to assure that qualified personnel properly gathered and evaluated the information submitted. Based on my inquiry of the person or persons who manage the system, or those persons directly responsible for gathering the information, the information submitted is, to the best of my knowledge and belief, true, accurate and complete. I am aware that there are significant penalties for submitting false information, including the possibility of fines and imprisonment for knowing violations. I understand that by submitting this Request for Termination and receiving written confirmation, I will no longer be authorized to discharge storm water associated with industrial activity under this general permit. Discharging pollutants in storm water associated with industrial activity to waters of the United States is unlawful under the Clean Water Act where the discharge is not authorized by a NPDES permit. I also understand that the submittal of this Request for Termination does not release an owner or operator from liability for any violations of this permit or the Clean Water Act.

Authorized Name (Print) Telephone Signature Date Signed

¹This application shall be signed according to the General Permit, ACT 15, T-4 as follows:

- For a corporation, by a responsible corporate officer.
- For a partnership, by a general partner.
- For a sole proprietorship, by the proprietor.
- For a municipal, state or other public facility, by principal executive officer, mayor, or ranking elected official.

After signing please mail to: Environmental Permits Division, Office of Pollution Control
P.O. Box 2261
Jackson, MS 39225

Revision: 2/16/2018

D Rock Mining, LLC. Pit No 1 – SWPPP
Hwy 84 Mine

APPENDIX A

Notice of Intent

Mining Storm Water, Dewatering, and No Discharge General Permit

D Rock Mining, LLC. Pit No 1 – SWPPP
Hwy 84 Mine

APPENDIX B

Figures and Erosion Control Drawings

Typical Silt Fence Installation

CONSTRUCTION OF A SILT FENCE (WITHOUT WIRE SUPPORT)

1. SET THE STAKES.

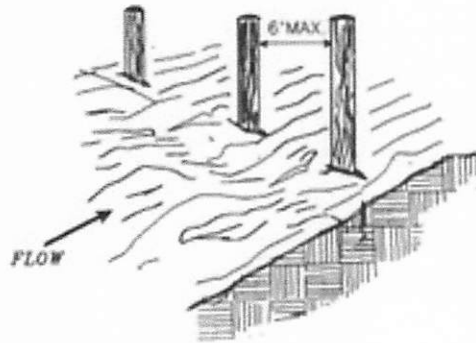

2. EXCAVATE A 4" X 4" TRENCH UPSLOPE ALONG THE LINE OF STAKES.

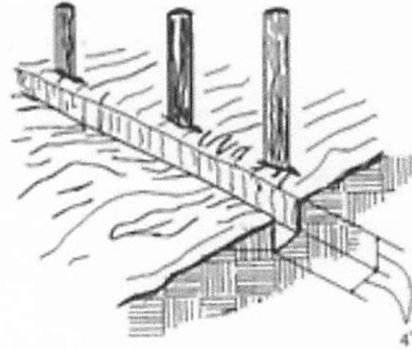

3. STAPLE FILTER MATERIAL TO STAKES AND EXTEND IT INTO THE TRENCH.

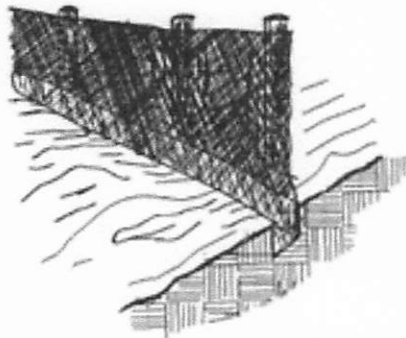

4. BACKFILL AND COMPACT THE EXCAVATED SOIL.

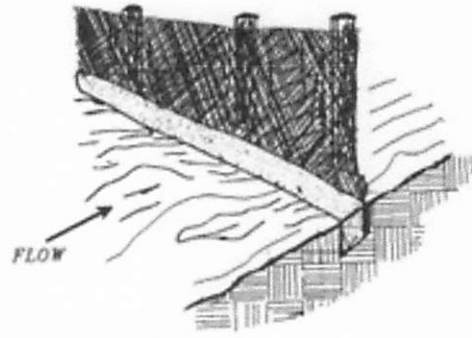

SHEET FLOW INSTALLATION
(PERSPECTIVE VIEW)

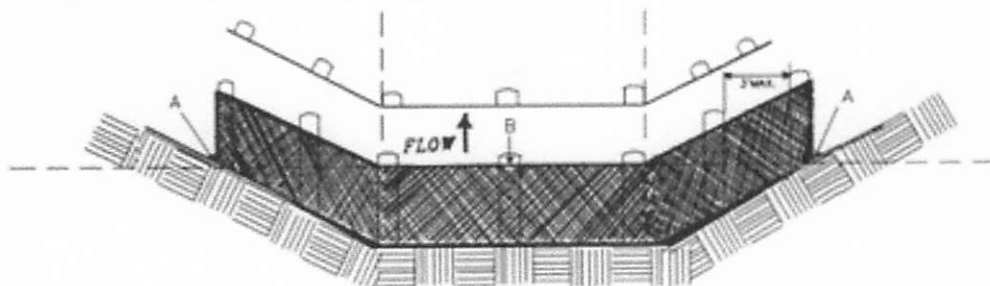

POINTS A SHOULD BE HIGHER THAN POINT B.
DRAINAGEWAY INSTALLATION
(FRONT ELEVATION)

Typical Silt Fence Installation

CONSTRUCTION OF A SILT FENCE (WITH WIRE SUPPORT)

1. SET POSTS AND EXCAVATE A 4"X4" TRENCH UPSLOPE ALONG THE LINE OF POSTS.

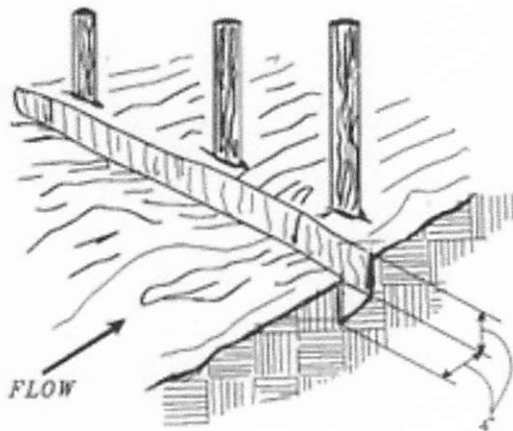

2. STAPLE WIRE FENCING TO THE POSTS.

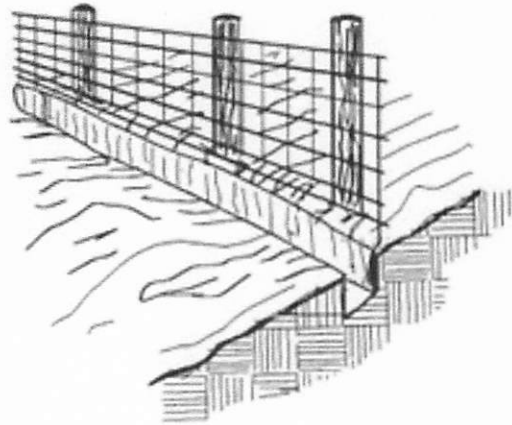

3. ATTACH THE FILTER FABRIC TO THE WIRE FENCE AND EXTEND IT INTO THE TRENCH.

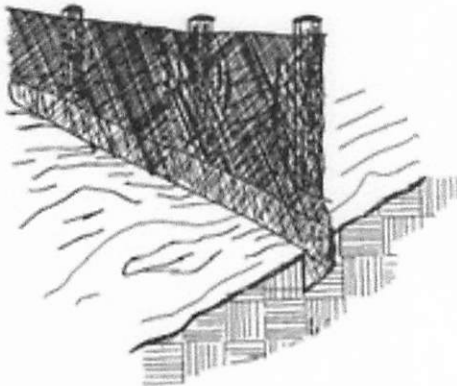

4. BACKFILL AND COMPACT THE EXCAVATED SOIL.

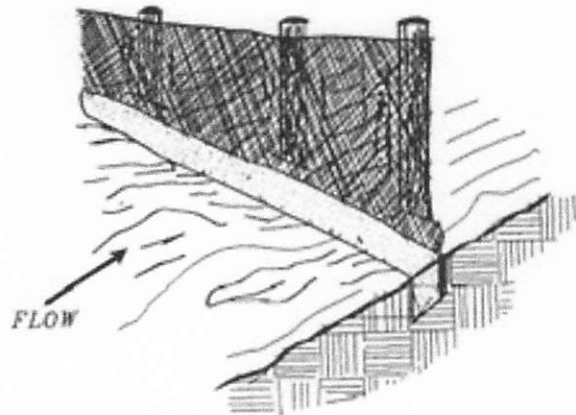

EXTENSION OF FABRIC AND WIRE INTO THE TRENCH

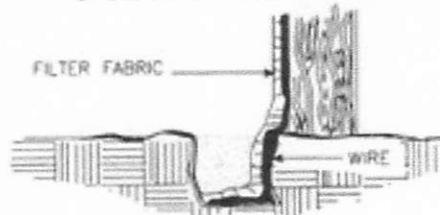

Typical Hay Bale Installation

- 1) Excavate the trench the width of the bale and 4" in height.

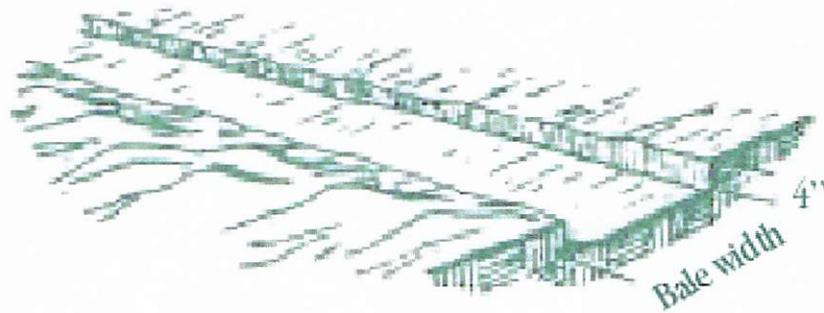

- 2) Place and stake the bales with 2 steel pickets or 2"x2" stakes. The first stake should be angled toward the previously laid bale. Trim or cap tops of stakes.

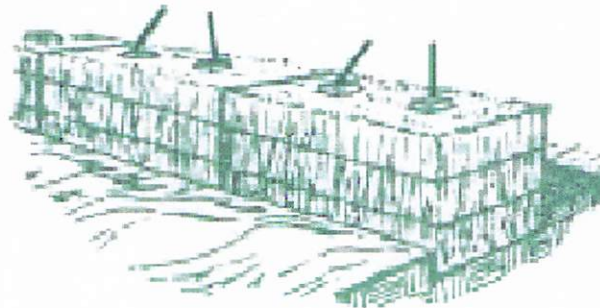

- 3) Wedge loose straw between bales.

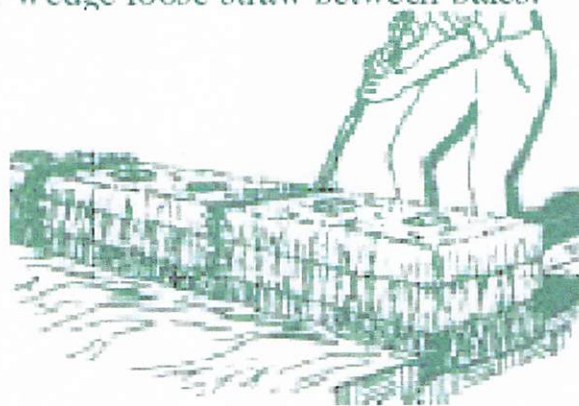

Typical Hay Bale Installation

4) Backfill and compact the excavated soil.

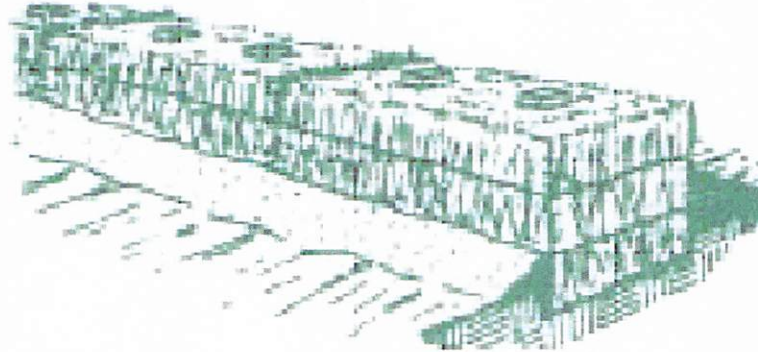

5) Cross section of a properly installed straw bale.

Staked and entrenched straw bale.

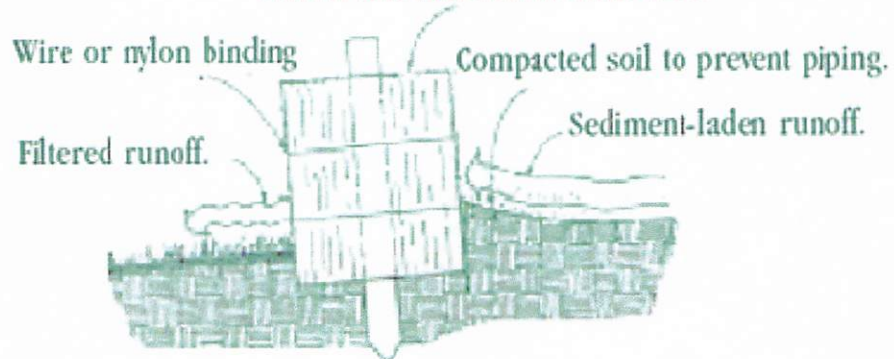

Typical Construction Entrance/Exit Stabilization

Type 1

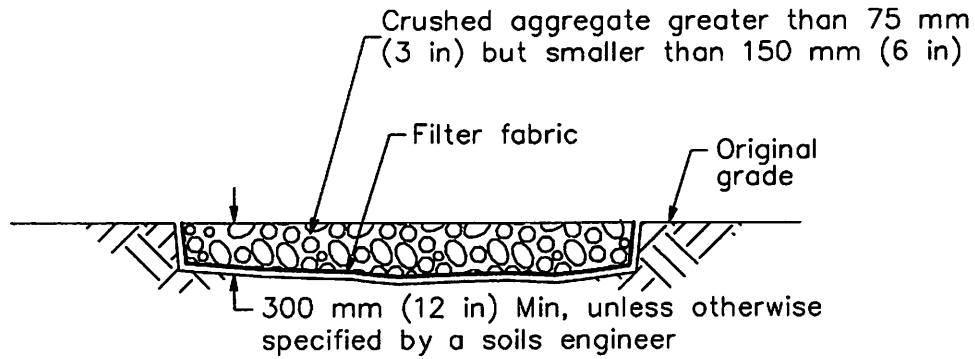

SECTION B-B
NTS

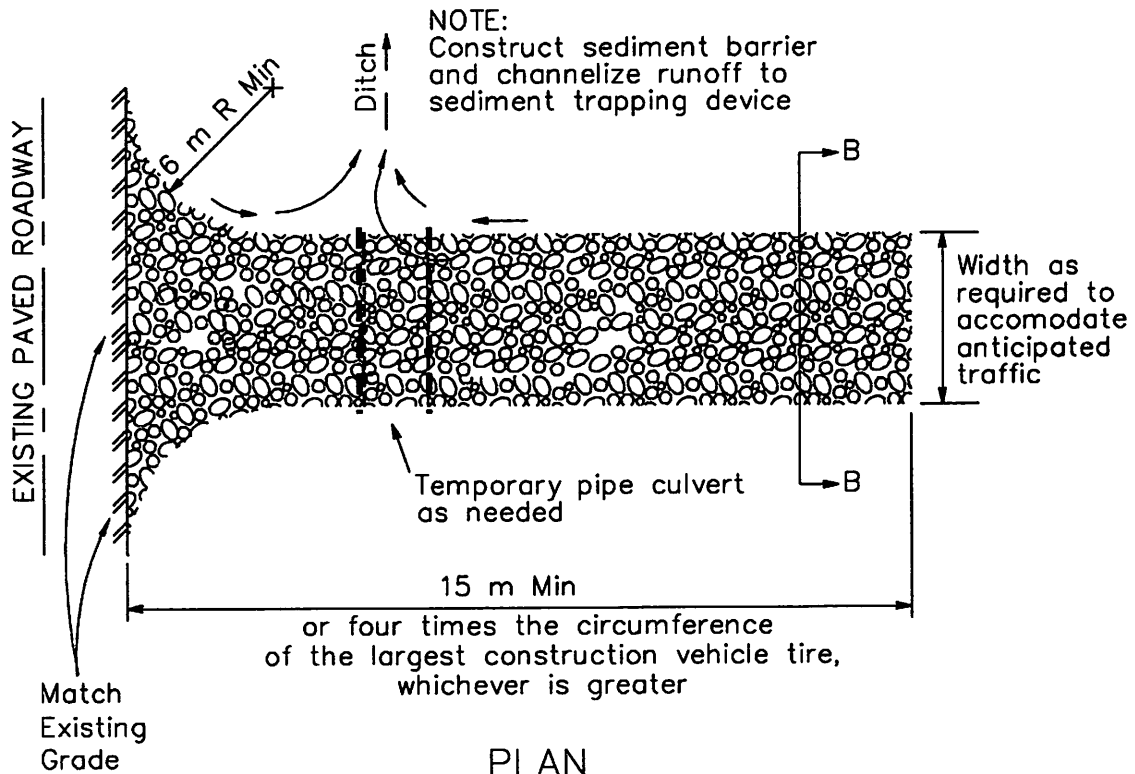

PLAN
NTS

Typical Construction Entrance/Exit Stabilization

Type 2

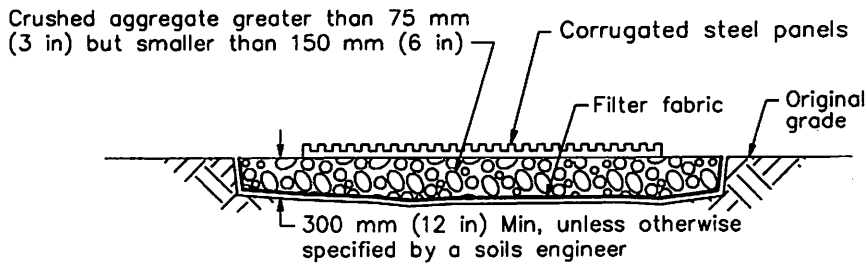
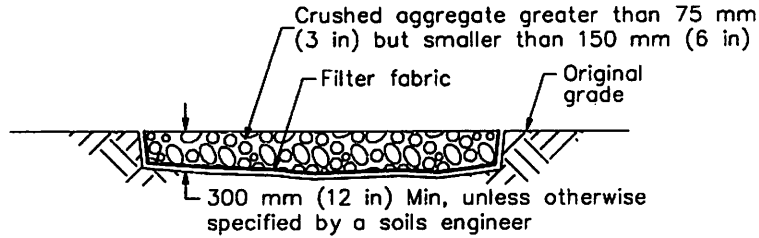

NOTE:
Construct sediment barrier and channelize runoff to sediment trapping device

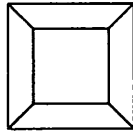

Sediment trapping device

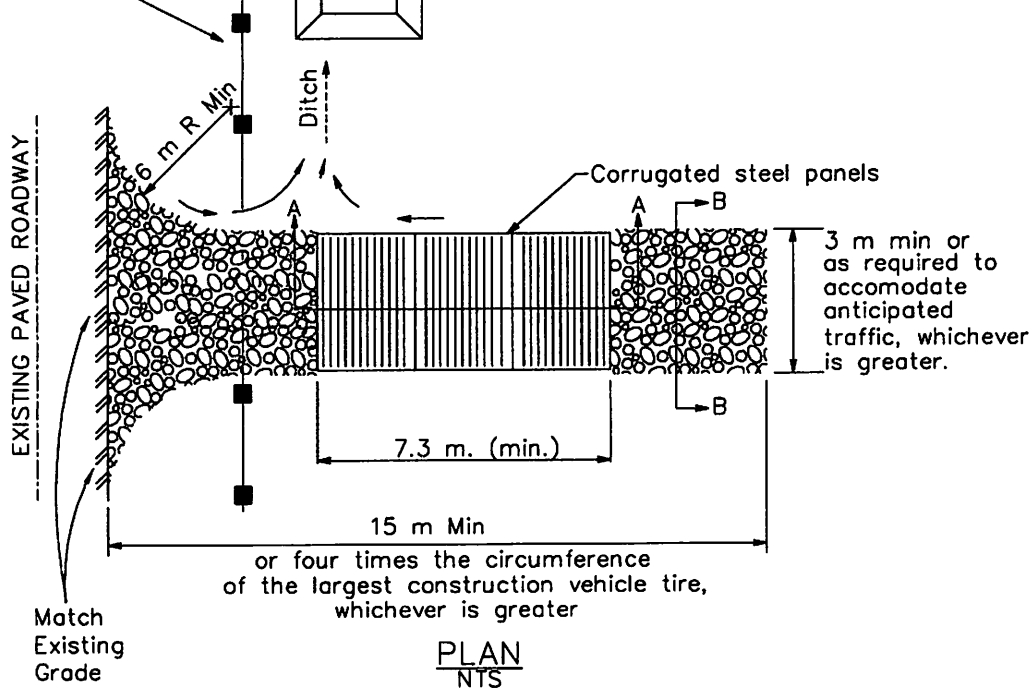

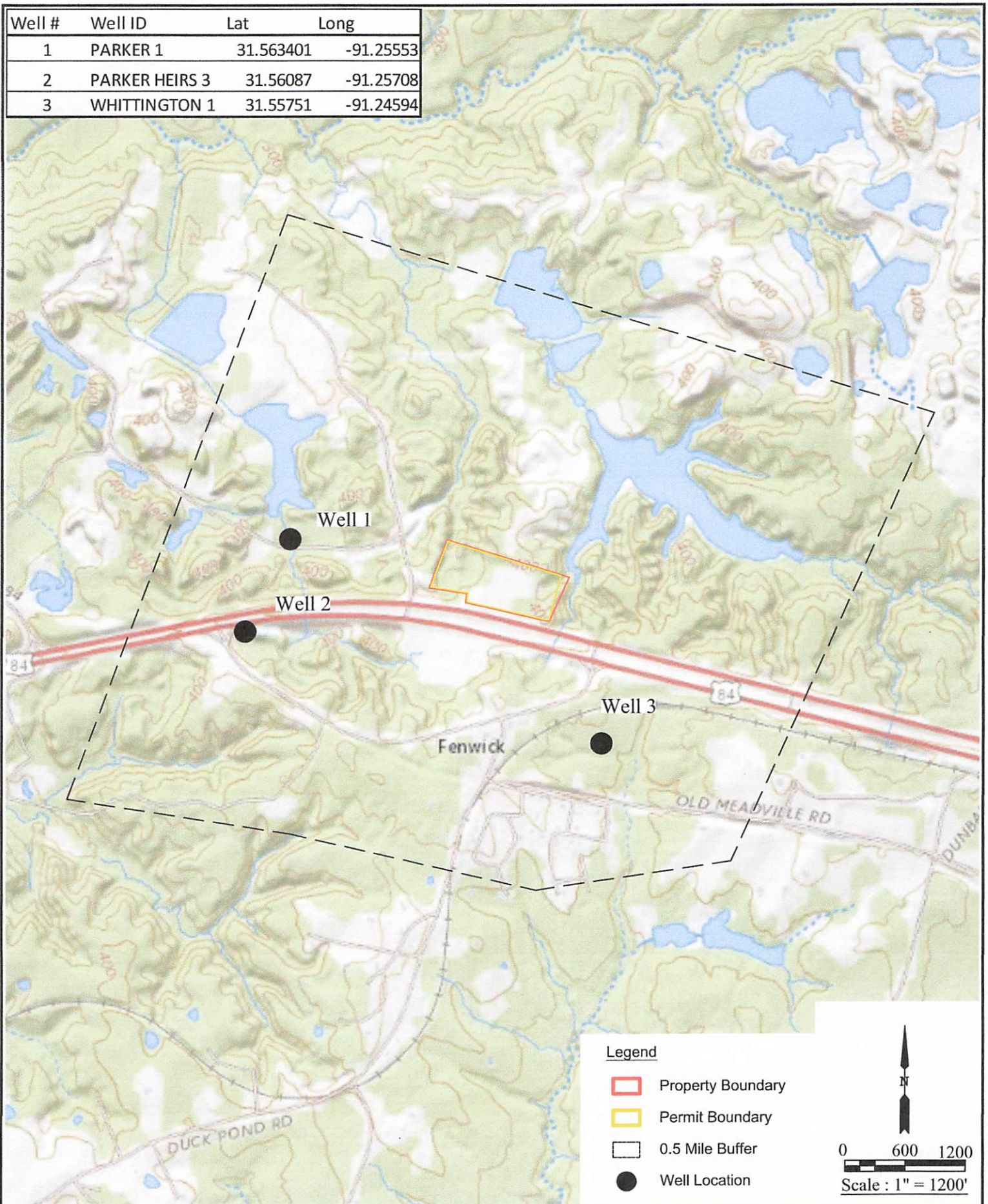

Well #	Well ID	Lat	Long
1	PARKER 1	31.563401	-91.25553
2	PARKER HEIRS 3	31.56087	-91.25708
3	WHITTINGTON 1	31.55751	-91.24594

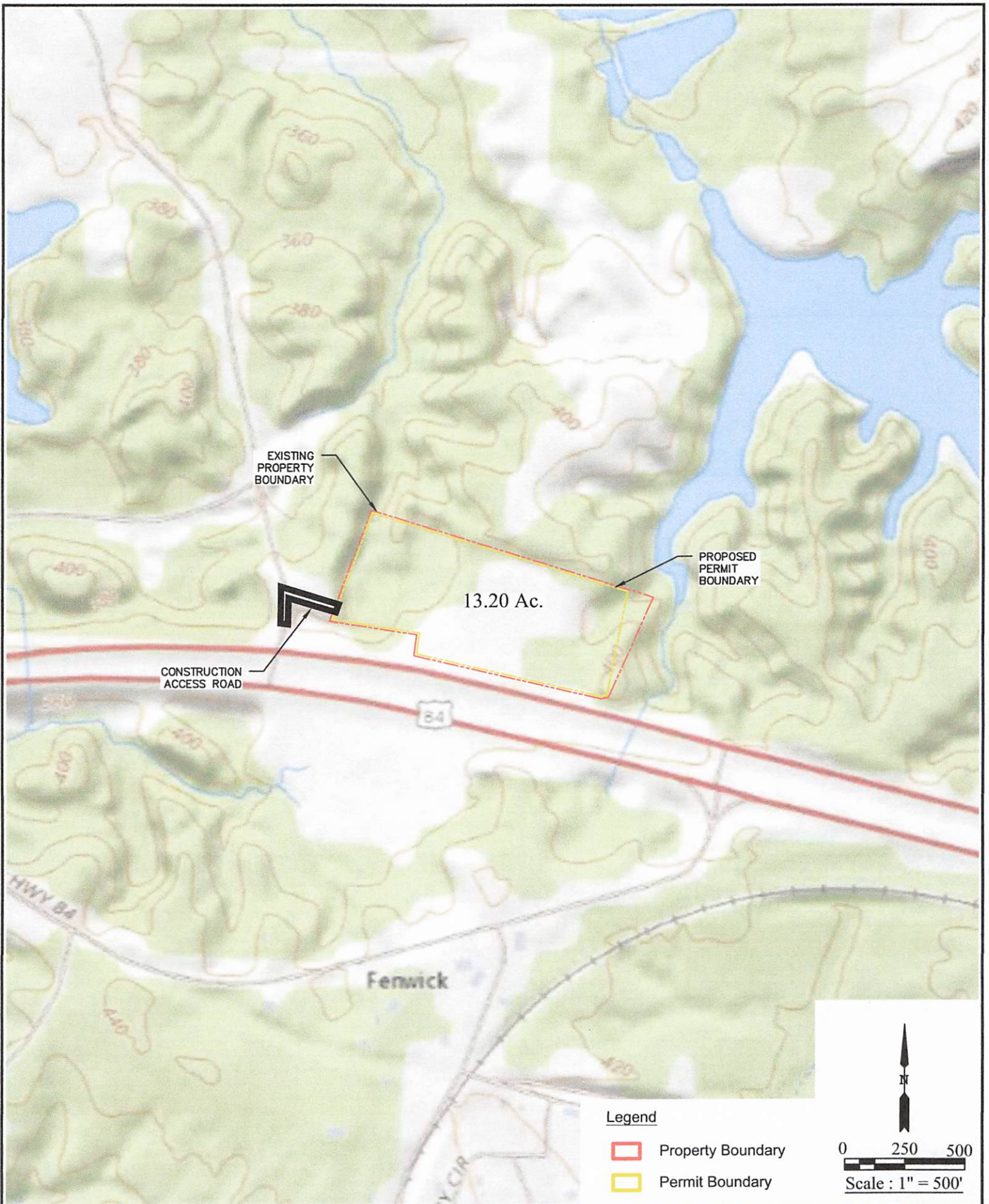

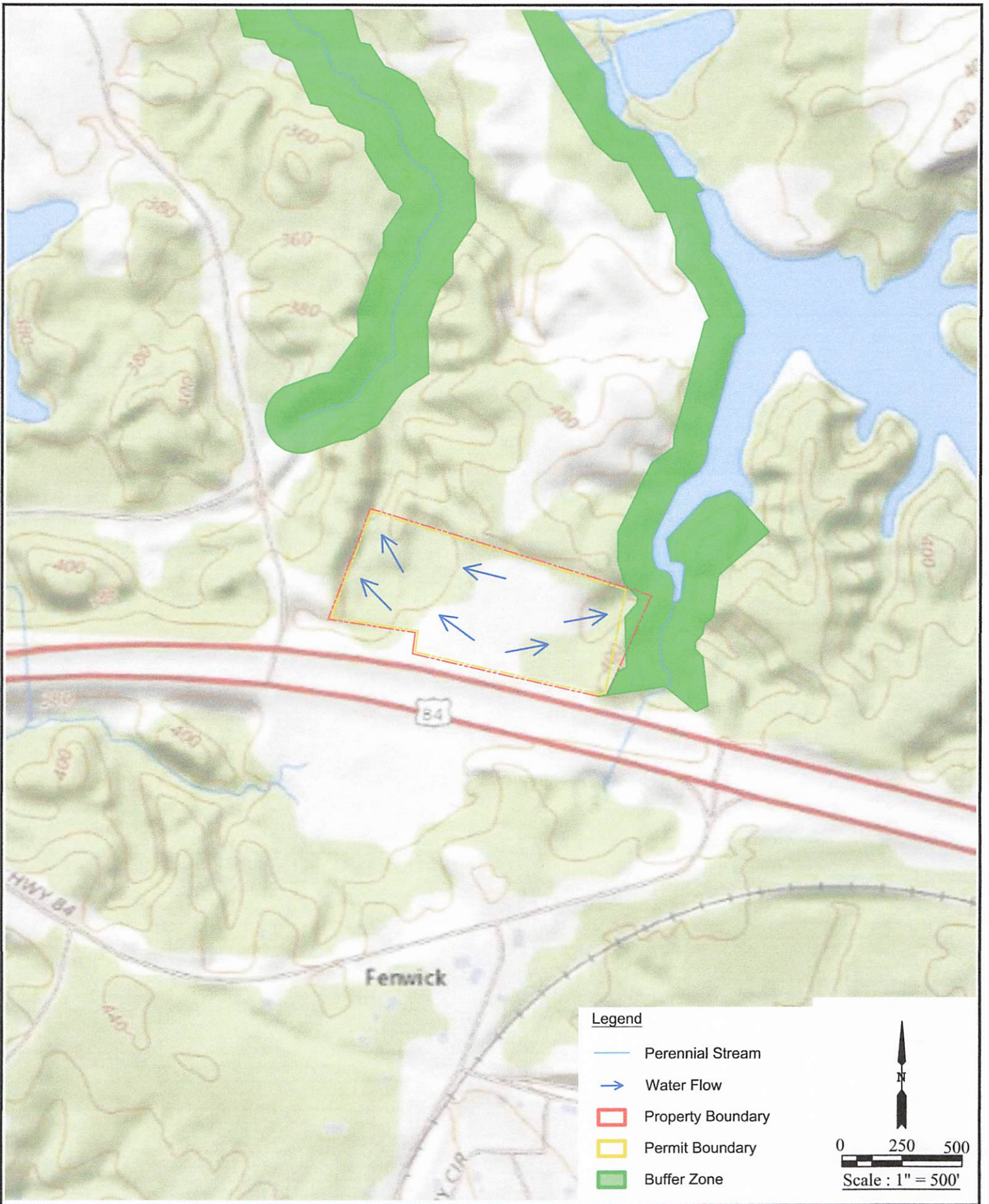



Legend

-  Perennial Stream
-  Water Flow
-  Property Boundary
-  Permit Boundary
-  Buffer Zone

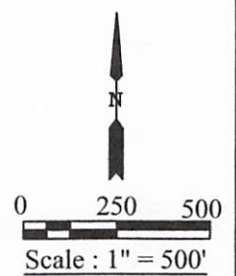

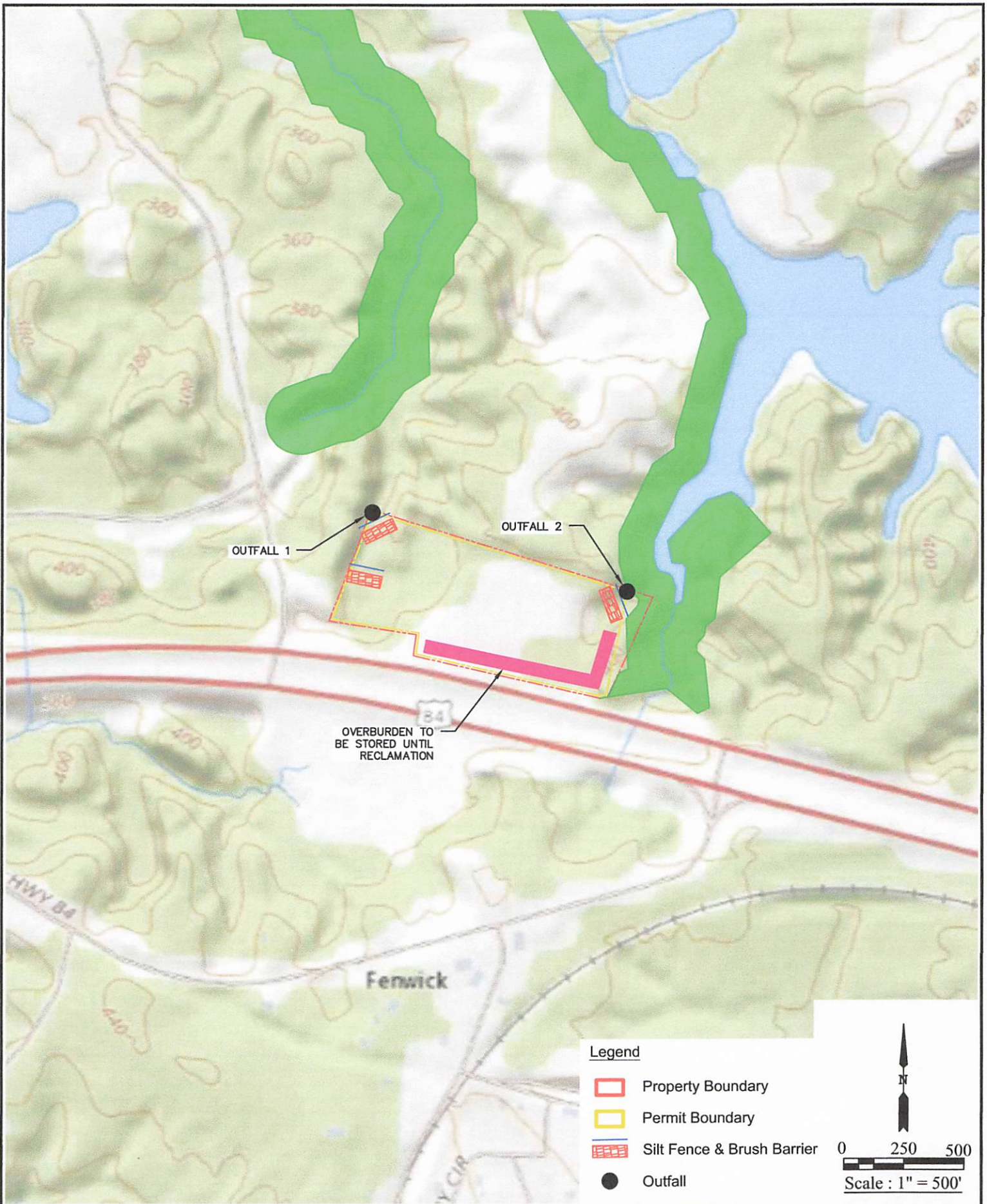



Legend

- Elevation Contours
- ▭ Property Boundary
- ▭ Mine Permit Boundary

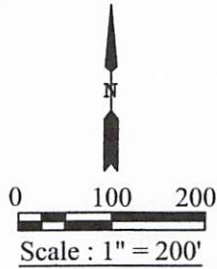



Legend

- Proposed Contours
- - - Elevation Contours
- ▭ Property Boundary
- ▭ Mine Permit Boundary

0 100 200
 Scale : 1" = 200'

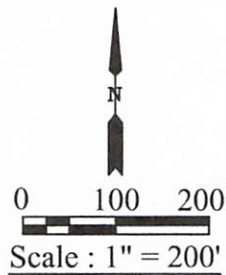
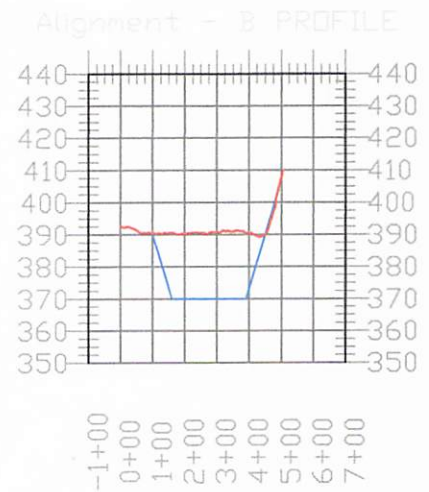
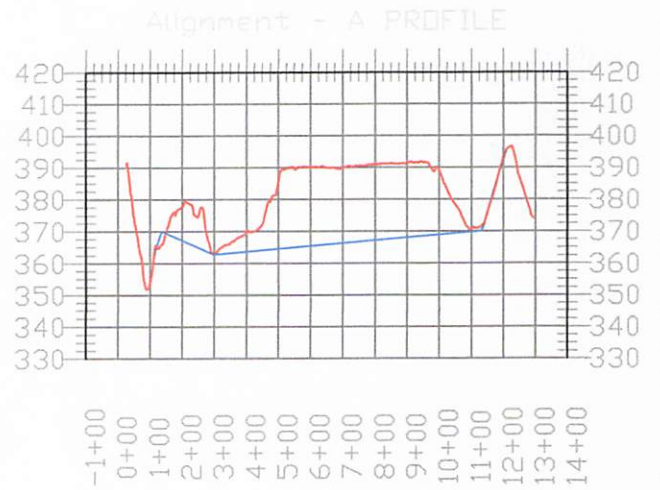
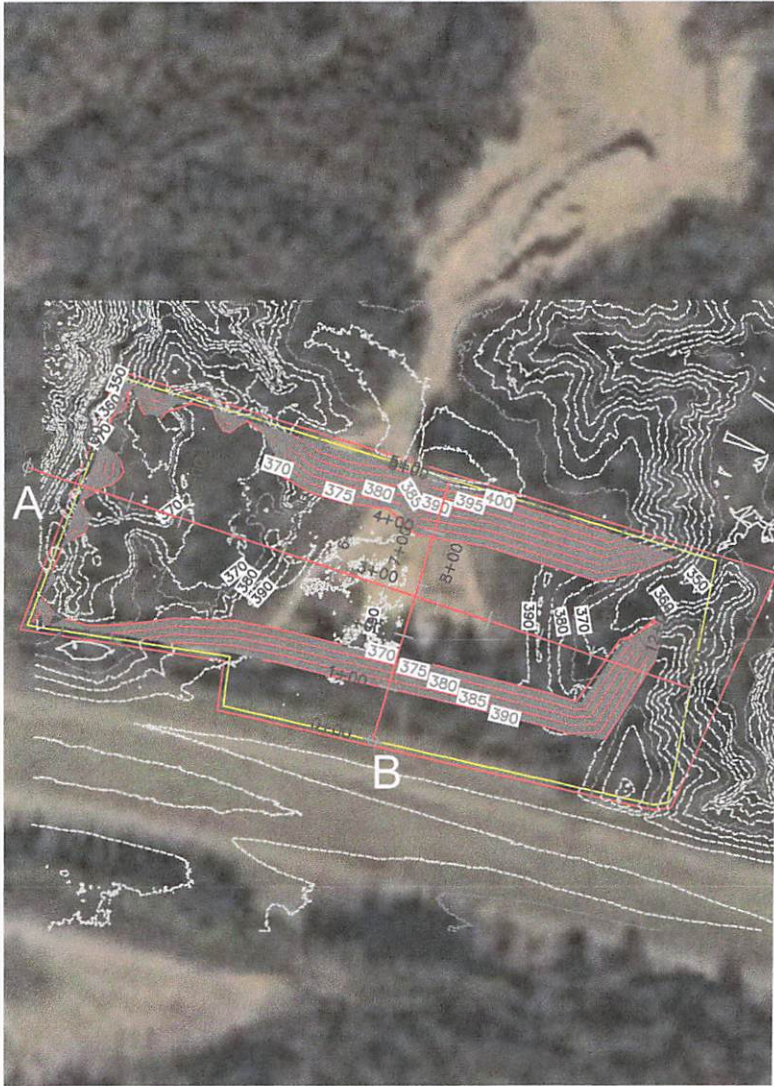

Legend

- Existing Ground Profile
- Post Mining Ground Profile

2024
(Approx. 6.6 Acres)

2025
(Approx. 6.6 Acres)

Legend

-  Mining Zones
-  Property Boundary
-  Mine Permit Boundary

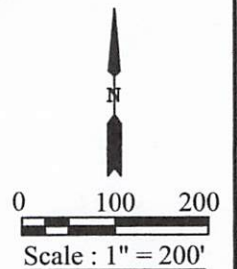



Corner ID	Latitude	Longitude
1	31.5224613°	-085.5398317°
2	31.5237061°	-085.5392351°
3	31.5226798°	-085.5357436°
4	31.5214638°	-085.5360738°
5	31.5220230°	-085.5386864°
6	31.5222703°	-085.5386381°

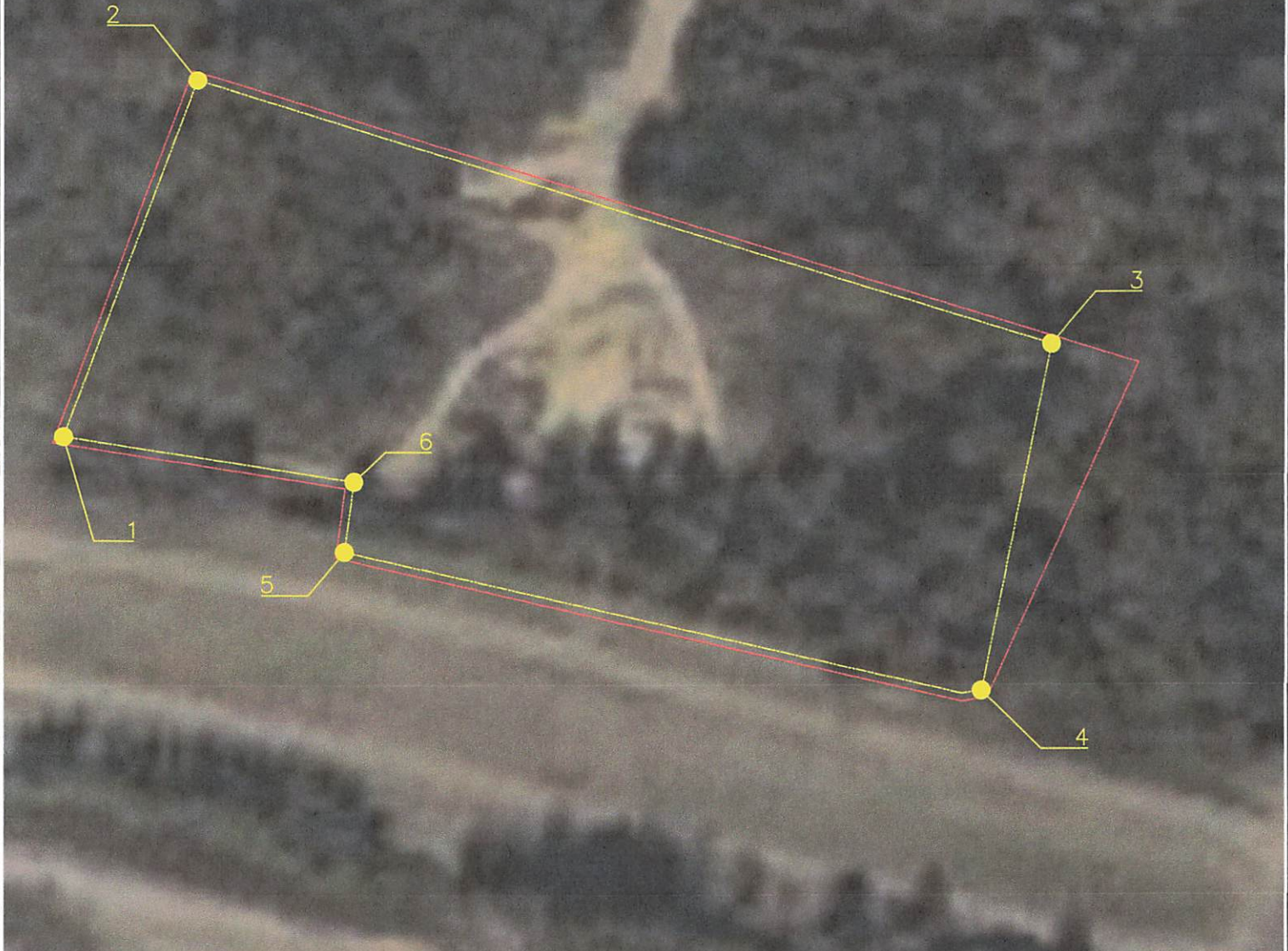

Legend

- Permit Boundary Corner
- Property Boundary
- Mine Permit Boundary

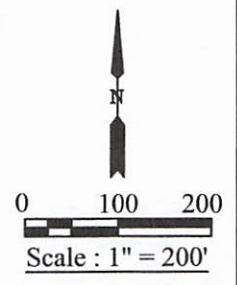

D Rock Mining, LLC. Pit No 1 – SWPPP
Hwy 84 Mine

APPENDIX C

Records of Monthly Inspections and Annual Report Forms

D Rock Mining, LLC. Pit No 1 – SWPPP
Hwy 84 Mine

APPENDIX D

Records of Annual Training

D Rock Mining, LLC. Pit No 1 – SWPPP
Hwy 84 Mine

APPENDIX E

Records of Significant Spills and Leaks & Notifications to Agencies