



August 8, 2024

Mississippi Office Of Pollution Control  
Municipal Permit Compliance Section  
515 E Amite St.  
Jackson, MS 39201

Re: Legacy Medical Park Subdivision (9 lots)  
City of Gautier  
COE No. SAM-2023-00513-KPJ  
WQC No. WQC

Gentlemen:

Submitted herewith is one (1) set of drainage construction plans for the above referenced consisting of the Erosion Control, Drainage and Detention Basin Details which includes the Storm Water Pollution Prevention Plan and Lot Maintenance Plan along with the post-construction elevations, grades and construction details. Also enclosed is the "Large Construction Notice of Intent (LCNOI)" for the Storm Water NPDES permit for your review and concurrence. A copy of the 'Will Serve' letter from the City of Gautier and OPC Information Form wastewater approval is available if needed.

Thank you for your assistance and please let us know if you have any questions or if any additional information is needed.

Yours very truly,

Dennis Stieffel, P.E.  
President

Enc.

896-3.wpd



MISSISSIPPI DEPARTMENT OF  
ENVIRONMENTAL QUALITY

**MISSISSIPPI DEPARTMENT OF  
ENVIRONMENTAL QUALITY (MDEQ)  
Large Construction Storm Water General Permit  
NPDES Permit MSR10**

# **LARGE CONSTRUCTION FORMS PACKAGE**

- **LARGE CONSTRUCTION NOTICE OF INTENT (LCNOI) FORM..... 2**
- **PRIME CONTRACTOR CERTIFICATION FORM..... 7**
- **REGISTRATION FORM FOR RESIDENTIAL LOT COVERAGE..... 8**
- **SITE INSPECTION AND CERTIFICATION FORM..... 12**
- **MAJOR MODIFICATION FORM..... 13**
- **REQUEST FOR TRANSFER OF PERMIT, GENERAL PERMIT COVERAGE  
AND/OR NAME CHANGE ..... 14**
- **INSPECTION SUSPENSION FORM..... 16**
- **REQUEST FOR TERMINATION OF COVERAGE ..... 17**

**These standard forms are used to apply for permit coverage under the Large Construction Storm Water General Permit and for submittals and record keeping required by permit conditions after coverage has been granted. The forms are on our website at [www.deq.state.ms.us/MDEQ.nsf/page/epd\\_epdgeneral](http://www.deq.state.ms.us/MDEQ.nsf/page/epd_epdgeneral). Required information can be completed on screen, printed and signed.**

AI: 86993

MSR109356



Rec'd via email:  
08/08/2024

MISSISSIPPI DEPARTMENT OF  
ENVIRONMENTAL QUALITY

## LARGE CONSTRUCTION NOTICE OF INTENT (LCNOI) FOR COVERAGE UNDER THE LARGE CONSTRUCTION STORM WATER GENERAL NPDES PERMIT

### INSTRUCTIONS

The Large Construction Notice of Intent (LCNOI) is for coverage under the Large Construction General Permit for land disturbing activities of five (5) acres or greater; or for land disturbing activities, which are part of a larger common plan of development or sale that are initially less than five (5) acres but will ultimately disturb five (5) or more acres. Applicant must be the owner or operator. For construction activities, the operator is typically the prime contractor. The owner(s) of the property and the prime contractor associated with regulated construction activity on the property have joint and severable responsibility for compliance with the Large Construction Storm Water General Permit MSR10.

If the company seeking coverage is a corporation, a limited liability company, a partnership, or a business trust, attach proof of its registration with the Mississippi Secretary of State and/or its Certificate of Good Standing. This registration or Certificate of Good Standing must be dated within twelve (12) months of the date of the submittal of this coverage form. Coverage will be issued in the company name as it is registered with the Mississippi Secretary of State.

Completed LCNOIs should be filed at least thirty (30) days prior to the commencement of construction. Discharge of storm water from large construction activities without written notification of coverage is a violation of state law.

Submittals with this LCNOI must include:

- A site-specific Storm Water Pollution Prevention Plan (SWPPP) developed in accordance with ACT5 of the General Permit
- A detailed site-specific scaled drawing showing the property layout and the features outlined in ACT5 of the General Permit
- A United States Geological Survey (USGS) quadrangle map or photocopy, extending at least one-half mile beyond the facility property boundaries with the site location and outfalls outlined or highlighted. The name of the quadrangle map must be shown on all copies. Quadrangle maps can be obtained from the MDEQ, Office of Geology at 601-961-5523.

Additional submittals may include the following, if applicable:

- Appropriate Section 404 documentation from U.S. Army Corps of Engineers
- Appropriate documentation concerning future disposal of sanitary sewage and sewage collection system construction
- Appropriate documentation from the MDEQ Office of Land & Water concerning dam construction and low flow requirements
- Approval from County Utility Authority in Hancock, Harrison, Jackson, Pearl River and Stone Counties

ALL QUESTIONS MUST BE ANSWERED (Answer "NA" if the question is not applicable)

O.C

APPLICANT IS THE:  OWNER  PRIME CONTRACTOR

### OWNER CONTACT INFORMATION

OWNER CONTACT PERSON: \_\_\_\_\_

OWNER COMPANY LEGAL NAME: \_\_\_\_\_

OWNER STREET OR P.O. BOX: \_\_\_\_\_

OWNER CITY: \_\_\_\_\_ STATE: \_\_\_\_\_ ZIP: \_\_\_\_\_

OWNER PHONE #: (\_\_\_\_) \_\_\_\_\_ OWNER EMAIL: \_\_\_\_\_

### PRIME CONTRACTOR CONTACT INFORMATION

PRIME CONTRACTOR CONTACT PERSON: \_\_\_\_\_

PRIME CONTRACTOR COMPANY LEGAL NAME: \_\_\_\_\_

PRIME CONTRACTOR STREET OR P.O. BOX: \_\_\_\_\_

PRIME CONTRACTOR CITY: \_\_\_\_\_ STATE: \_\_\_\_\_ ZIP: \_\_\_\_\_

PRIME CONTRACTOR PHONE #: (\_\_\_\_) \_\_\_\_\_ PRIME CONTRACTOR EMAIL: \_\_\_\_\_

### FACILITY SITE INFORMATION

FACILITY SITE NAME: \_\_\_\_\_

FACILITY SITE ADDRESS (If the physical address is not available, please indicate the nearest named road. For linear projects indicate the beginning of the project and identify all counties the project traverses.)

STREET: \_\_\_\_\_

CITY: \_\_\_\_\_ STATE: \_\_\_\_\_ COUNTY: \_\_\_\_\_ ZIP: \_\_\_\_\_

FACILITY SITE TRIBAL LAND ID (N/A If not applicable): \_\_\_\_\_

LATITUDE: \_\_\_\_ degrees \_\_\_\_ minutes \_\_\_\_ seconds LONGITUDE: \_\_\_\_ degrees \_\_\_\_ minutes \_\_\_\_ seconds

LAT & LONG DATA SOURCE (GPS (Please GPS Project Entrance/Start Point) or Map Interpolation): \_\_\_\_\_

TOTAL ACREAGE THAT WILL BE DISTURBED <sup>1</sup>: \_\_\_\_\_

IS THIS PART OF A LARGER COMMON PLAN OF DEVELOPMENT? YES  NO

IF YES, NAME OF LARGER COMMON PLAN OF DEVELOPMENT: \_\_\_\_\_  
AND PERMIT COVERAGE NUMBER: MSR10 \_\_\_\_\_

ESTIMATED CONSTRUCTION PROJECT START DATE: \_\_\_\_\_  
YYYY-MM-DD

ESTIMATED CONSTRUCTION PROJECT END DATE: \_\_\_\_\_  
YYYY-MM-DD

DESCRIPTION OF CONSTRUCTION ACTIVITY: \_\_\_\_\_

PROPOSED DESCRIPTION OF PROPERTY USE AFTER CONSTRUCTION HAS BEEN COMPLETED: \_\_\_\_\_

SIC Code \_\_\_\_ NAICS Code \_\_\_\_\_

NEAREST NAMED RECEIVING STREAM: \_\_\_\_\_

IS RECEIVING STREAM ON MISSISSIPPI'S 303(d) LIST OF IMPAIRED WATER BODIES? (The 303(d) list of impaired waters and TMDL stream segments may be found on MDEQ's web site: [http://www.deq.state.ms.us/MDEQ.nsf/page/TWB\\_Total\\_Maximum\\_Daily\\_Load\\_Section](http://www.deq.state.ms.us/MDEQ.nsf/page/TWB_Total_Maximum_Daily_Load_Section)) YES  NO

HAS A TMDL BEEN ESTABLISHED FOR THE RECEIVING STREAM SEGMENT? YES  NO

ARE THERE RECREATIONAL STREAMS, PRIVATE/PUBLIC PONDS OR LAKES WITHIN ½ MILE DOWNSTREAM OF PROJECT BOUNDARY THAT MAY BE IMPACTED BY THE CONSTRUCTION ACTIVITY? YES  NO

EXISTING DATA DESCRIBING THE SOIL (for linear projects please describe in SWPPP):  
\_\_\_\_\_

WILL FLOCCULANTS BE USED TO TREAT TURBIDITY IN STORM WATER? YES  NO

IF YES, INDICATE THE TYPE OF FLOCCULANT.  ANIONIC POLYACRYLAMIDE (PAM)  
 OTHER \_\_\_\_\_

IF YES, DOES THE SWPPP DESCRIBE THE METHOD OF INTRODUCTION, THE LOCATION OF INTRODUCTION AND THE LOCATION OF WHERE FLOCCULATED MATERIAL WILL SETTLE? YES  NO

<sup>1</sup>Acreage for subdivision development includes areas disturbed by construction of roads, utilities and drainage. Additionally, a housesite of at least 10,000 ft<sup>2</sup> per lot (entire lot, if smaller) shall be included in calculating acreage disturbed.

**DOCUMENTATION OF COMPLIANCE WITH OTHER REGULATIONS/REQUIREMENTS**  
COVERAGE UNDER THIS PERMIT WILL NOT BE GRANTED UNTIL ALL OTHER REQUIRED  
MDEQ PERMITS AND APPROVALS ARE SATISFACTORILY ADDRESSED

IS LCNOI FOR A FACILITY THAT WILL REQUIRE OTHER PERMITS? YES  NO

IF YES, CHECK ALL THAT APPLY:  AIR  HAZARDOUS WASTE  PRETREATMENT  
 WATER STATE OPERATING  INDIVIDUAL NPDES  OTHER: \_\_\_\_\_

IS THE PROJECT REROUTING, FILLING OR CROSSING A WATER CONVEYANCE OF ANY KIND? (If yes, contact the U.S. Army Corps of Engineers' Regulatory Branch for permitting requirements.) YES  NO

IF THE PROJECT REQUIRES A CORPS OF ENGINEER SECTION 404 PERMIT, PROVIDE APPROPRIATE DOCUMENTATION THAT:

- The project has been approved by individual permit, or
- The work will be covered by a nationwide permit and NO NOTIFICATION to the Corps is required, or
- The work will be covered by a nationwide or general permit and NOTIFICATION to the Corps is required

IS A LAKE REQUIRING THE CONSTRUCTION OF A DAM BEING PROPOSED? YES  NO   
(If yes, provide appropriate approval documentation from MDEQ Office of Land and Water, Dam Safety.)

IF THE PROJECT IS A SUBDIVISION OR A COMMERCIAL DEVELOPMENT, HOW WILL SANITARY SEWAGE BE DISPOSED? Check one of the following and attach the pertinent documents.

- Existing Municipal or Commercial System. Please attach plans and specifications for the collection system and the associated "Information Regarding Proposed Wastewater Projects" form or approval from County Utility Authority in Hancock, Harrison, Jackson, Pearl River and Stone Counties. If the plans and specifications can not be provided at the time of LCNOI submittal, MDEQ will accept written acknowledgement from official(s) responsible for wastewater collection and treatment that the flows generated from the proposed project can and will be transported and treated properly. The letter must include the estimated flow.
- Collection and Treatment System will be Constructed. Please attach a copy of the cover of the NPDES discharge permit from MDEQ or indicate the date the application was submitted to MDEQ (Date: \_\_\_\_\_.)
- Individual Onsite Wastewater Disposal Systems for Subdivisions Less than 35 Lots. Please attach a copy of the Letter of General Acceptance from the Mississippi State Department of Health or certification from a registered professional engineer that the platted lots should support individual onsite wastewater disposal systems.
- Individual Onsite Wastewater Disposal Systems for Subdivisions Greater than 35 Lots. A determination of the feasibility of installing a central sewage collection and treatment system must be made by MDEQ. A copy of the response from MDEQ concerning the feasibility study must be attached. If a central collection and wastewater system is not feasible, then please attach a copy of the Letter of General Acceptance from the State Department of Health or certification from a registered professional engineer that the platted lots should support individual onsite wastewater disposal systems.

INDICATE ANY LOCAL STORM WATER ORDINANCE WITH WHICH THE PROJECT MUST COMPLY:

---

---

I certify under penalty of law that this document and all attachments were prepared under my direction or supervision in accordance with a system designed to assure that qualified personnel properly gathered and evaluated the information submitted. Based on my inquiry of the person or persons who manage the system, or those persons directly responsible for gathering the information, the information submitted is, to the best of my knowledge and belief, true, accurate and complete. I am aware that there are significant penalties for submitting false information, including the possibility of fine and imprisonment for knowing violations.

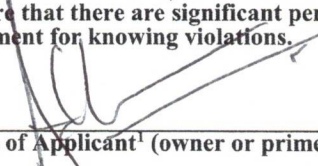

Signature of Applicant<sup>1</sup> (owner or prime contractor)

8/7/2024

Date Signed

Dr. Satjit Adlakha

Printed Name<sup>1</sup>

Member

Title

<sup>1</sup>This application shall be signed as follows:

- For a corporation, by a responsible corporate officer.
- For a partnership, by a general partner.
- For a sole proprietorship, by the proprietor.

For a municipal, state or other public facility, by principal executive officer, mayor, or ranking elected official

Please submit the LCNOI form to:

Chief, Environmental Permits Division  
MS Department of Environmental Quality, Office of Pollution Control  
P.O. Box 2261  
Jackson, Mississippi 39225

# PRIME CONTRACTOR CERTIFICATION

## LARGE CONSTRUCTION GENERAL PERMIT

Coverage No. MSR10 \_\_\_\_\_ County \_\_\_\_\_

(Fill in your Certificate of Coverage Number and County)



MISSISSIPPI DEPARTMENT OF ENVIRONMENTAL QUALITY

By completing and submitting this form to MDEQ, the prime contractor is certifying that (1) they have operational control over the erosion and sediment control specifications (including the ability to make modifications to such specifications) or (2) they have day-to-day operational control of those activities at the site necessary to ensure compliance with the SWPPP and applicable permit conditions.

The owner(s) of the property and the prime contractor associated with regulated construction activity on the property have joint and severable responsibility for compliance with the permit. Notwithstanding any permit condition to the contrary, the coverage recipient and any person who causes pollution of waters of the state or places waste in a location where they are likely to cause pollution of any waters of the state shall remain responsible under applicable federal and state laws and regulations and applicable permits.

### PRIME CONTRACTOR INFORMATION

PRIME CONTRACTOR CONTACT PERSON: \_\_\_\_\_ PHONE NUMBER: (\_\_\_\_) \_\_\_\_\_

PRIME CONTRACTOR COMPANY: \_\_\_\_\_

PRIME CONTRACTOR STREET (P.O. BOX): \_\_\_\_\_

PRIME CONTRACTOR CITY: \_\_\_\_\_ STATE: \_\_\_\_\_ ZIP: \_\_\_\_\_

E-MAIL ADDRESS: \_\_\_\_\_

### OWNER INFORMATION

OWNER CONTACT PERSON: \_\_\_\_\_ PHONE NUMBER: (\_\_\_\_) \_\_\_\_\_

OWNER COMPANY NAME: \_\_\_\_\_

### PROJECT INFORMATION

PROJECT NAME: \_\_\_\_\_

DESCRIPTION OF CONSTRUCTION ACTIVITY: \_\_\_\_\_

PHYSICAL SITE ADDRESS (If the physical address is not available indicate the nearest named road. For linear projects, indicate the beginning of the project and identify all counties the project traverses.)

STREET: \_\_\_\_\_

CITY: \_\_\_\_\_ COUNTY: \_\_\_\_\_

I certify that I am the prime contractor for this project and will comply with all the requirements in the above referenced general NPDES permit. I further certify under penalty of law that this document and all attachments were prepared under my direction or supervision in accordance with a system designed to assure that qualified personnel properly gathered and evaluated the information submitted. Based on my inquiry of the person or persons who manage the system, or those persons directly responsible for gathering the information, the information submitted is, to the best of my knowledge and belief, true, accurate and complete. I am aware that there are significant penalties for submitting false information, including the possibility of fine and imprisonment for knowing violations.

\_\_\_\_\_  
Prime Contractor Signature<sup>1</sup>

\_\_\_\_\_  
Date Signed

\_\_\_\_\_  
Printed Name<sup>1</sup>

\_\_\_\_\_  
Title

- <sup>1</sup>This application shall be signed as follows:
- For a corporation, by a responsible corporate officer.
  - For a partnership, by a general partner.
  - For a sole proprietorship, by the proprietor.
  - For a municipal, state or other public facility, by principal executive officer, mayor, or ranking elected official.

This Prime Contractors Certification form shall be submitted to:

Chief, Environmental Permits Division  
MS Department of Environmental Quality, Office of Pollution Control  
P.O. Box 2261  
Jackson, Mississippi 39225



Keep a Copy at the Construction Site and Also Submit this Page to:  
 Chief, Environmental Permits Division  
 MS Department of Environmental Quality, Office of Pollution Control  
 P.O. Box 2261  
 Jackson, Mississippi 39225-2261



## Registration Form for Residential Lot Coverage under Mississippi's Large Construction Storm Water General Permit INSTRUCTIONS

Coverage recipients for residential subdivision construction that do not retain responsibility for permit compliance for individual lots are to furnish this Registration to buyers of individual lots at the time of purchase. In addition, the attached Requirements for Individual Lots in Residential Subdivisions, the Site Inspection and Certification Form and the Large Construction Storm Water General Permit shall also be given to buyers of individual lots at the time of purchase. This form is providing notification to buyers of lots in residential developments, that being part of a "larger common plan of development or sale," coverage is required under Mississippi's Large Construction Storm Water General Permit. To comply with the permit, **the Registration Form must be submitted to MDEQ** at the address listed above and a Storm Water Pollution Prevention Plan (SWPPP) must be developed and implemented to reduce pollutants in storm water discharges during construction activity. **The SWPPP is not required to be submitted to MDEQ.** A copy of the SWPPP and Registration Form must be kept at the construction site or locally available (i.e., able to be produced within an hour of being requested by a state or local inspector). See the following attachments for information on SWPPP development. In addition, **a copy of the completed Registration Form(s) must be retained by the developer and submitted to the MDEQ when requesting termination of permit coverage.** If the buyer or homebuilder sells the lot before a house is built, they must provide this form to the new owner. All questions must be answered. Answer "NA" if the question is not applicable. For further information, contact MDEQ at 601/961-5171 or access our website address: [www.deq.state.ms.us/MDEQ.nsf/page/epd\\_epdgeneral](http://www.deq.state.ms.us/MDEQ.nsf/page/epd_epdgeneral).

<b>ORIGINAL COVERAGE RECIPIENT NAME:</b> _____ <b>COMPANY NAME:</b> _____ <b>STREET OR P.O. BOX:</b> _____ <b>CITY:</b> _____ <b>STATE:</b> _____ <b>ZIP:</b> _____ <b>PHONE # (INCLUDE AREA CODE):</b> _____	<b>BUYER / HOMEBUILDER:</b> _____ <b>COMPANY NAME (IF APPROPRIATE):</b> _____ <b>STREET OR P.O. BOX:</b> _____ <b>CITY:</b> _____ <b>STATE:</b> _____ <b>ZIP:</b> _____ <b>BUYER PHONE # (INCLUDE AREA CODE):</b> _____
---	---

**RESIDENTIAL SUBDIVISION NAME:** \_\_\_\_\_

**LARGE CONSTRUCTION STORM WATER PERMIT COVERAGE NUMBER: MSR10:** \_\_\_\_\_

**LOT NUMBER(s) (attach an additional sheet if necessary):** \_\_\_\_\_ **LOT SIZE(s):** \_\_\_\_\_

**PHYSICAL SITE ADDRESS (IF NOT AVAILABLE INDICATE THE NEAREST NAMED ROAD):**

**STREET:** \_\_\_\_\_

**CITY:** \_\_\_\_\_ **COUNTY:** \_\_\_\_\_ **ZIP:** \_\_\_\_\_

I certify under penalty of law that this document and all attachments were prepared under my direction or supervision in accordance with a system designed to assure that qualified personnel properly gathered and evaluated the information submitted. Based on my inquiry of the persons or persons who manage the system, or those persons directly responsible for gathering the information, the information submitted is, to the best of my knowledge and belief, true, accurate and complete. I am aware that there are significant penalties for submitting false information, including the possibility of fine and imprisonment for knowing violations. As a buyer / homebuilder, I further certify that I have read and understand the terms and conditions of Mississippi's Large Construction Storm Water General Permit and that I am responsible for installing and maintaining the appropriate pollution control measures for the purchased lot(s) identified.

<b>Original Coverage Recipient Signature<sup>1</sup></b>	<b>Date Signed</b>
<b>Printed Name</b>	<b>Title</b>
<b>Buyer / Homebuilder Signature<sup>1</sup></b>	<b>Date Signed</b>
<b>Printed Name</b>	<b>Title</b>

<sup>1</sup>This application shall be signed according to ACT11, T-7 of the Large Construction General Permit.

## REQUIREMENTS FOR LOTS IN RESIDENTIAL SUBDIVISION WHICH ARE COVERED BY THE LARGE CONSTRUCTION STORM WATER GENERAL PERMIT

As a homebuilder on a lot that is part of a regulated subdivision, you are also regulated under the State's storm water regulations and are required to take steps to keep soil and sediment from leaving the lot. When rain falls on exposed soil it can wash away valuable topsoil. It also carries sediment, nutrients and other pollutants into streets, gutters and ditches, where it then travels to lakes, rivers, streams or wetlands. Polluted runoff can cause excessive growth of aquatic weeds and algae and reduce recreational opportunities such as swimming and fishing. Sediment laden runoff can also destroy fish habitat reducing productive fishing opportunities. In addition, sediment-laden runoff can also clog pipes, ditches, streams and basins resulting in increased flooding and maintenance cost. Therefore, the homebuilder is required to minimize off-site damage from soil erosion, sediment leaving the construction site, and poor "housekeeping" practices. This requirement must be accomplished by developing and implementing a Storm Water Pollution Prevention Plan (SWPPP). Some examples of individual lot SWPPPs are attached for your convenience. Sketch the controls on a copy of your site plan. Narrative notes on the site plan may also be used in addition to the erosion control symbols.

In developing and implementing the SWPPP, controls must be used from each control group (vegetative, structural, housekeeping) to prevent erosion and sediment and other pollutants from leaving the site. Commonly used controls include:

### Vegetative Controls

**Temporary vegetation** includes annual grasses that sprout quickly such as annual rye, browntop millet, oats, and winter wheat. These grow quickly with little care and can protect the soil from rainfall and act as a filter. They will not provide permanent cover. Permanent cover must be established as indicated below. When a disturbed area will be left undisturbed for fourteen (14) days or more, the appropriate temporary or permanent vegetative practices shall be implemented immediately.

**Mulching** is the placement of hay grass, woodchips, straw, or synthetic material on the soil to provide temporary cover to protect the soil from rain. Mulching may be the only option during the winter when seeding or sodding is not possible. Mulch must stay in place to be effective. Netting, stakes or chemical binders are used to anchor some types of mulch. Be sure to reinstall washed-out mulch and anchor if necessary until permanent cover is established.

**Permanent stabilization** is the establishment of a permanent vegetative cover on disturbed areas using either sod, perennial seed, trees or shrubs. When a disturbed area will be left undisturbed for fourteen (14) days or more, the appropriate temporary or permanent vegetative practices shall be implemented immediately. Silt fences, and other temporary measures must be removed following permanent stabilization.

**Vegetative buffer zones** are undisturbed or planted vegetated areas that are between construction activities and water bodies.

### Structural Controls

**Silt fences** are temporary sediment barriers made of filter fabric buried at the bottom, stretched, and supported by stakes. The silt fence slows runoff and allows it to puddle or pond, so soil and sediment can settle out before leaving the site. The bottom eight to twelve inches of fence must either be sliced in or buried in a trench about four to six inches deep by four to six inches wide. **Silt fences that are not buried are improperly installed. They have no useful function, are a waste of money, and may result in enforcement action.** Stakes must be on the downstream side of the fence and spaced about 3 feet apart. Silt fence must not be installed across streams, ditches, waterways, or other concentrated flow areas. Place fences on the contour or perpendicular to the slope of the hill so that water and sediment will pond behind the fence. **Turn ends uphill** to prevent water going around the end. Install on the downslope, downhill, downstream, or low side of your lot. Keep the fence/barrier in place until grass is established.

**Slope drains** are piping or lined channels that carry storm water downslope without erosion. A good example would be a downspout extender. Extenders may be used to protect temporarily stabilized areas from roof runoff. Extenders can direct water from roof gutters to paved or grassed areas. Remove extenders following permanent stabilization.

**Construction entrance/exits** are stone stabilized site entrances which reduce sediment tracked onto public roads. Apply gravel or crushed rock to the driveway area and restrict traffic to this one route. Use 3 to 6 inch gravel over a geotextile fabric. At the end of each day sweep or scrape up any soil tracked onto the street. Limit "standard" vehicle access (including workers' vehicles) to only streets and roads, keep vehicles off of future yard areas; limit tracking of mud onto streets by requiring any required vehicles to use designated access drives. Streets are conduits for storm water, it is important to keep mud and sediment off the streets.

**Stockpiles** of sand or soil should be covered with plastic or tarps at the end of each workday, or surrounded with silt fence or haybales. Do not locate a stockpile near a street, storm drain inlet, or ditch.

**Erosion control blankets or mats** are machine-produced mats of straw or other fibers held together with netting that provide temporary or permanent stabilization in critical areas, such as slopes or channels, so that vegetation may be established.

**Storm Drain Inlets** on the lot must be protected by surrounding or covering with a filter material until final stabilization has been achieved.

**Additional Controls:** The above controls are the more common practices used at small construction sites. There are a number of other controls, techniques and manufactured product available. A few examples include hydro seeding, diversion berms, silt dikes and fiber logs. Even something as simple as a tarp or plastic may provide temporary cover for small exposed areas. You may wish to contact an erosion and sediment control specialist, local building official, or MDEQ for further information. In addition, MDEQ has several guidance manuals that may be of assistance and the internet has abundant guidance on construction BMPs.

**Housekeeping Controls:** Pollutants that may enter storm water from construction sites because of poor housekeeping include oils, grease, paints, gasoline, solvents, litter, debris, and sanitary waste. Good housekeeping practices include:

- Frequent cleaning of trash and debris, providing waste receptacles at convenient locations and providing regular collection of waste;
- Directing concrete trucks to the subdivision's designated wash-off area(s) or back to the Ready-Mix facility;
- Providing protected storage areas for chemicals, paints, solvents, fertilizers, and other potentially toxic materials; and
- Providing adequately maintained sanitary facilities.

In addition, you should be aware that State air regulations prohibit the open burning of residential solid waste.

**Inspection Requirements.** Homebuilders shall inspect all erosion controls as often as is necessary, but no less than weekly, to ensure that appropriate erosion and sediment controls have been properly constructed and maintained to prevent erosion and sediment from leaving the site and determine if additional or alternative control measures are required. The inspection results shall be recorded on the Site Inspection and Certification Form contained in the Large Construction Forms Package. MDEQ strongly recommends that homebuilders perform "walk through" inspections daily. It is a responsibility of the homebuilder to install additional and/or alternative erosion and sediment controls when existing controls prove to be ineffective in preventing sediment from leaving the site.

**Retention of Records.** All records, reports, forms and information resulting from activities required by this permit shall be retained for a period of at least three years from the date of the document origin.

**Duty to Comply.** Lot owners must comply with the applicable permit conditions. See Activities 3, 5, 6, 7, 10 and 11 in the Large Construction Storm Water General Permit for applicable conditions. Any noncompliance with the applicable permit conditions and aforementioned conditions including sediment leaving the lot constitutes a violation of the Mississippi Water Pollution Control Law and is grounds for enforcement action. It shall not be an acceptable defense that controls were not installed because subsequent activities would require their replacement or cause their destruction.

# EXAMPLE INDIVIDUAL LOT EROSION AND SEDIMENT CONTROL PLANS

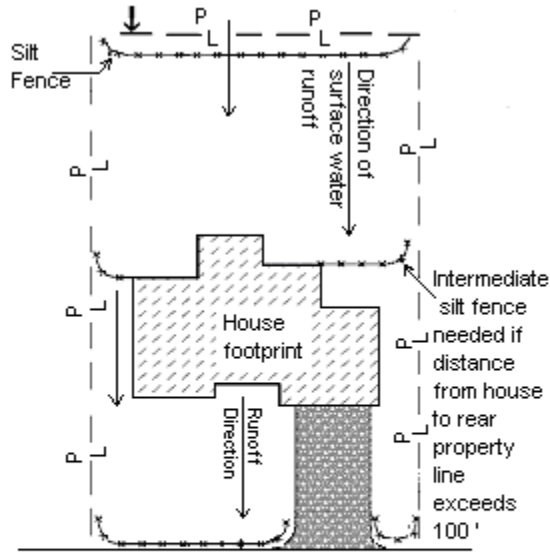

- Street
- Silt Fence
- Gravel construction entrance
- ← Direction of surface water runoff
- P Property Line
- L

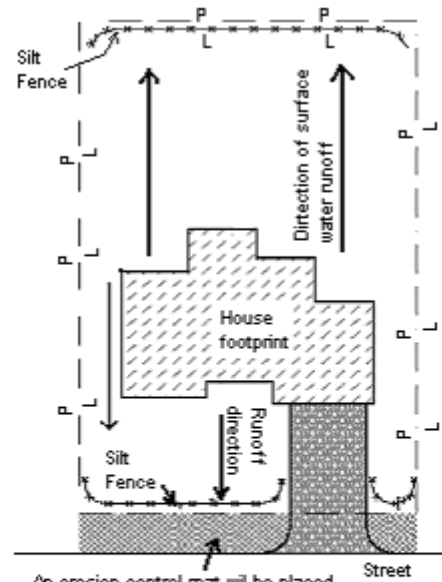

- An erosion control mat will be placed at this critical area (steep slope) in order to establish grass
- Silt fence
- Gravel construction entrance
- ← Direction of surface water runoff
- Erosion control mat
- P Property Line
- L

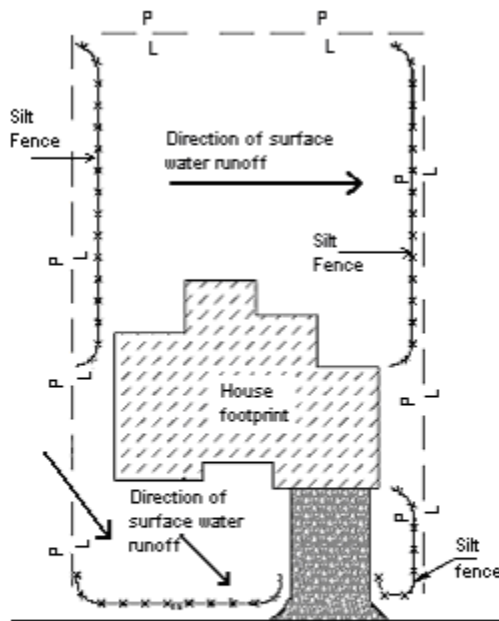

- Silt fence
- Gravel construction entrance
- ← Direction of surface water runoff
- P Property Line
- L

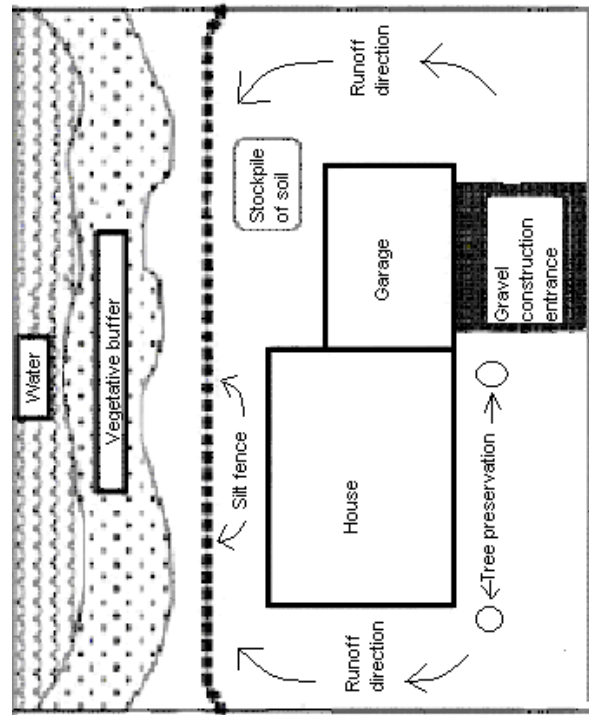

All disturbed areas will be temporarily seeded with ryegrass. After final grade has been reached, all disturbed areas will be sodded with bermuda grass.

**Keep a Copy Available at the Permitted Facility or Locally Available**  
**Submit the Inspection Reports Only if Requested by the Mississippi Department of Environmental Quality (MDEQ)**

**LARGE CONSTRUCTION GENERAL PERMIT  
 SITE INSPECTION AND CERTIFICATION FORM  
 COVERAGE NUMBER (MSR10 \_ \_ \_ \_)**



**INSTRUCTIONS**

**Results of construction storm water inspections required by ACT6 of this permit shall be recorded on this report form and kept with the Storm Water Pollution Prevention Plan (SWPPP) in accordance with the inspection documentation provisions of ACT9 of the this permit. Inspections shall be performed at least weekly for a minimum of four inspections per month. The coverage number must be listed at the top of all Inspection and Certification Forms.**

**COVERAGE RECIPIENT INFORMATION**

**OWNER/PRIME CONTRATOR NAME:** \_\_\_\_\_

**PROJECT NAME:** \_\_\_\_\_

**PROJECT STREET ADDRESS:** \_\_\_\_\_

**PROJECT CITY:** \_\_\_\_\_ **PROJECT COUNTY:** \_\_\_\_\_

**OWNER/PRIME CONTRACTOR MAILING ADDRESS:** \_\_\_\_\_

**MAILING CITY:** \_\_\_\_\_ **STATE:** \_\_\_\_\_ **ZIP:** \_\_\_\_\_

**CONTACT PERSON:** \_\_\_\_\_ **CONTACT PHONE NUMBER: (\_\_\_\_\_)** \_\_\_\_\_

**EMAIL ADDRESS:** \_\_\_\_\_

**INSPECTION DOCUMENTATION**

DATE (mo/day/yr)	TIME (hr:min AM/PM)	ANY DEFICIENCIES? (CHECK IF YES)	INSPECTOR(S)
		<input type="checkbox"/>	
		<input type="checkbox"/>	
		<input type="checkbox"/>	
		<input type="checkbox"/>	
		<input type="checkbox"/>	
		<input type="checkbox"/>	

Deficiencies Noted During any Inspection (give date(s); attach additional sheets if necessary): \_\_\_\_\_

\_\_\_\_\_

\_\_\_\_\_

Corrective Action Taken or Planned (give date(s); attach additional sheets if necessary): \_\_\_\_\_

\_\_\_\_\_

\_\_\_\_\_

Based upon this inspection, which I or personnel under my direct supervision conducted, I certify that all erosion and sediment controls have been implemented and maintained, except for those deficiencies noted above, in accordance with the Storm Water Pollution Prevention Plan (SWPPP) and sound engineering practices as required by the above referenced permit. I further certify that the LCNOI and SWPPP information is up to date.

I certify under penalty of law that this document and all attachments were prepared under my direction or supervision in accordance with a system designed to assure that qualified personnel properly gather and evaluate the information submitted. Based on my inquiry of the person or persons responsible for gathering the information, the information submitted is, to the best of my knowledge and belief, true, accurate and complete. I am aware that there are significant penalties for submitting false information, including the possibility of fines and imprisonment for knowing violations.

\_\_\_\_\_  
 Authorized Signature

\_\_\_\_\_  
 Date

\_\_\_\_\_  
 Printed Name

\_\_\_\_\_  
 Title

**MAJOR MODIFICATION FORM  
FOR LARGE CONSTRUCTION GENERAL PERMIT**  
Coverage No. MSR10 \_\_\_\_\_ County \_\_\_\_\_



MISSISSIPPI DEPARTMENT OF ENVIRONMENTAL QUALITY

**INSTRUCTIONS**

Coverage recipients shall notify the Mississippi Department of Environmental Quality at least 30 days in advance of the following activities (check all that apply). This form should be submitted with a modified Storm Water Pollution Prevention Plan (SWPPP), updated USGS topographic map, Corps of Engineers Section 404 documentation and wastewater collection and treatment information, as appropriate.

SWPPP details have been developed and are ready for MDEQ review for subsequent phases of an existing, covered project.

"Footprint" identified in the original LCNOI is proposed to be enlarged.

This form must be signed by the current coverage recipient under Mississippi's Large Construction General Permit. A different developer of new phases of existing subdivisions must apply for separate permit coverage through the submittal of a new complete LCNOI package. Coverage recipients are authorized to discharge storm water associated with proposed expansions of existing subdivisions or subsequent phases, under the conditions of the General Permit, only upon receipt of written notification of approval by MDEQ. All other modifications, such as changes of erosion and sediment controls used, must be in accordance with ACT6, S-1 (6) and S-2 (7) of the General Permit.

ALL INFORMATION MUST BE COMPLETED (indicate "N/A" where not applicable)

**COVERAGE RECIPIENT INFORMATION**

COVERAGE RECIPIENT CONTACT NAME: \_\_\_\_\_ TEL # (\_\_\_\_) \_\_\_\_\_

COMPANY NAME: \_\_\_\_\_

STREET OR P.O. BOX: \_\_\_\_\_

CITY: \_\_\_\_\_ STATE: \_\_\_\_\_ ZIP: \_\_\_\_\_ E-MAIL: \_\_\_\_\_

**PROJECT INFORMATION**

PROJECT NAME: \_\_\_\_\_

CITY: \_\_\_\_\_

ADDITIONAL ACREAGE TO BE DISTURBED: \_\_\_\_\_ TOTAL PROJECT ACREAGE: \_\_\_\_\_

I certify under penalty of law that this document and all attachments were prepared under my direction or supervision in accordance with a system designed to assure that qualified personnel properly gathered and evaluated the information submitted. Based on my inquiry of the person or persons who manage the system, or those persons directly responsible for gathering the information, the information submitted is, to the best of my knowledge and belief, true, accurate and complete. I am aware that there are significant penalties for submitting false information, including the possibility of fine and imprisonment for knowing violations.

\_\_\_\_\_  
Signature (must be signed by coverage recipient)

\_\_\_\_\_  
Date

\_\_\_\_\_  
Printed Name

\_\_\_\_\_  
Title

Please submit this form to:

Chief, Environmental Permits Division  
MS Department of Environmental Quality, Office of Pollution Control  
P.O. Box 2261  
Jackson, Mississippi 39225

# Environmental Permits for Industrial Facilities

## Request for Transfer of Permit, General Permit Coverage and/or Name Change

Instructions: For Ownership Change-Complete all Items on Page 1 (except Item VIII) and Page 2 (reverse side).  
 For Name Change Only-Complete Items I, II, V, VI, VII, VIII, and Page 2 (reverse side).

Note-This form should be submitted to MDEQ when a transferal date is finalized but prior to the actual transfer.

<p>Item I.</p> <p>Facility Name: _____</p> <p>Location: (Do Not Use P.O. Box)</p> <p style="padding-left: 40px;">Street: _____</p> <p style="padding-left: 40px;">City: _____ State: <u>MS</u> Zip: _____</p> <p>County: _____</p> <p>Telephone: (_____) _____</p>	<p>Item II.</p> <p>Responsible official after transfer or name change:</p> <p>Name: _____</p> <p>Title: _____</p> <p>Mailing Address:</p> <p style="padding-left: 40px;">Street/P.O. Box: _____</p> <p style="padding-left: 40px;">City: _____ State: _____ Zip: _____</p> <p>Telephone (_____) _____</p>								
<p>Item III.</p> <p>Previous Permittee<sup>1</sup>: _____</p> <p>Mailing Address:</p> <p style="padding-left: 40px;">Street/P.O. Box: _____</p> <p style="padding-left: 40px;">City: _____ State: _____ Zip: _____</p> <p>Telephone: (_____) _____</p>	<p>Item IV.</p> <p>New Permittee<sup>1</sup>: _____</p> <p>Mailing Address:</p> <p style="padding-left: 40px;">Street/P.O. Box: _____</p> <p style="padding-left: 40px;">City: _____ State: _____ Zip: _____</p> <p>Telephone: (_____) _____</p>								
<p>Item V.</p> <p>Industrial Activity      SIC Code: _____</p> <p>Brief Description:</p>	<p>Item VI.</p> <p>Will Facility Operations Change?    Yes _____ No _____</p> <p>If yes, the appropriate applications and permits may require modification prior to change.</p>								
<p>Item VII.</p> <p>Will Facility Name Change?    Yes _____ No _____</p> <p>If Yes, Provide New Name for Permit Coverage.</p> <p>New Name: _____</p>	<p>Item VIII.</p> <p>Signature for Name Change</p> <p>Print Name: _____</p> <p>Authorized Signature<sup>2</sup>: _____</p> <p>Title: _____ Date: _____</p>								
<p>Item IX.</p> <p>We the undersigned request transfer of permit(s) and/or permit coverage(s) listed on the backside of this form.</p> <p>From: _____</p> <p>To: _____ Acquisition Date: _____</p> <p>By signature below, the recipient certifies that: 1) they are aware of the requirements of the permit(s), 2) the applicant can demonstrate to the Permit Board it has the financial resources and operational expertise and 3) agrees to accept responsibility and liability for the permit(s) listed on the back of this document. By signature below, the previous permittee is requesting that the permit(s) and/or permit coverage(s) be transferred to the recipient. The transfer of the permit(s) or permit coverage(s) will be by written notification from the Office of Pollution Control (OPC). The OPC may require submittal of information regarding financial capability and past compliance history of the recipient.</p> <table style="width: 100%; margin-top: 20px;"> <tr> <td style="width: 50%; border-bottom: 1px solid black; padding-bottom: 5px;">Print New Permittee<sup>1</sup> Name</td> <td style="width: 50%; border-bottom: 1px solid black; padding-bottom: 5px;">Print Previous Permittee<sup>1</sup> Name</td> </tr> <tr> <td style="border-bottom: 1px solid black; padding-bottom: 5px;">New Authorized Signature<sup>2</sup></td> <td style="border-bottom: 1px solid black; padding-bottom: 5px;">Previous Authorized Signature<sup>2</sup></td> </tr> <tr> <td style="border-bottom: 1px solid black; padding-bottom: 5px;">Title</td> <td style="border-bottom: 1px solid black; padding-bottom: 5px;">Title</td> </tr> <tr> <td style="border-bottom: 1px solid black; padding-bottom: 5px;">Date</td> <td style="border-bottom: 1px solid black; padding-bottom: 5px;">Date</td> </tr> </table>		Print New Permittee <sup>1</sup> Name	Print Previous Permittee <sup>1</sup> Name	New Authorized Signature <sup>2</sup>	Previous Authorized Signature <sup>2</sup>	Title	Title	Date	Date
Print New Permittee <sup>1</sup> Name	Print Previous Permittee <sup>1</sup> Name								
New Authorized Signature <sup>2</sup>	Previous Authorized Signature <sup>2</sup>								
Title	Title								
Date	Date								

<sup>1</sup>A Permittee is a company or individual that has been issued an individual permit or coverage under a general permit.

<sup>2</sup>Authorized Signature must be owner or in the case of a corporation, a corporate officer as defined in Regulations 11 Miss. Admin. Code Pt. 2, Ch. 2. and 11 Miss. Admin. Code Pt. 6, Ch. 1.

**Mississippi Department of Environmental Quality/Office of Pollution Control**  
**P.O. Box 2261**  
**Jackson, Mississippi 39225**  
**(601) 961-5171**

<p>Item X. Storm Water</p> <p>(Check One)</p> <p><input type="checkbox"/> A Storm Water Pollution Prevention Plan (SWPPP) is not required for the site.</p> <p><input type="checkbox"/> The recipient certifies that they have received a copy of the Office of Pollution Control approved SWPPP from the original owner.</p> <p><input type="checkbox"/> The recipient is submitting a new SWPPP, which is attached to this form.</p> <p><input type="checkbox"/> A copy of the SWPPP cannot be obtained from the original owner.</p>	<p>Item XI. Hazardous Waste ID Number</p> <p>EPA ID No. _____</p> <p>(Check One)</p> <p><input type="checkbox"/> An EPA Hazardous Waste ID Number is not required for the site.</p> <p><input type="checkbox"/> The site's EPA ID Number is listed above and a Notification of Regulated Waste Activity Form is attached.</p>
--	---

**Item XII. Permit(s) and/or Coverage(s) to be Transferred**

<p>Permit Type: _____</p> <p>Permit/Coverage No.: _____</p> <p>Permit Issuance Date: _____</p> <p>Date of General Permit Coverage: _____</p> <p>Permit Expiration Date: _____</p>	<p>Permit Type: _____</p> <p>Permit/Coverage No.: _____</p> <p>Permit Issuance Date: _____</p> <p>Date of General Permit Coverage: _____</p> <p>Permit Expiration Date: _____</p>
---	---

<p>Permit Type: _____</p> <p>Permit/Coverage No.: _____</p> <p>Permit Issuance Date: _____</p> <p>Date of General Permit Coverage: _____</p> <p>Permit Expiration Date: _____</p>	<p>Permit Type: _____</p> <p>Permit/Coverage No.: _____</p> <p>Permit Issuance Date: _____</p> <p>Date of General Permit Coverage: _____</p> <p>Permit Expiration Date: _____</p>
---	---

<p>Permit Type: _____</p> <p>Permit/Coverage No.: _____</p> <p>Permit Issuance Date: _____</p> <p>Date of General Permit Coverage: _____</p> <p>Permit Expiration Date: _____</p>	<p>Permit Type: _____</p> <p>Permit/Coverage No.: _____</p> <p>Permit Issuance Date: _____</p> <p>Date of General Permit Coverage: _____</p> <p>Permit Expiration Date: _____</p>
---	---

<p>Permit Type: _____</p> <p>Permit/Coverage No.: _____</p> <p>Permit Issuance Date: _____</p> <p>Date of General Permit Coverage: _____</p> <p>Permit Expiration Date: _____</p>	<p>OTHER INFORMATION:</p>
---	---------------------------



# INSPECTION SUSPENSION FORM

## UNDER LARGE CONSTRUCTION STORM WATER GENERAL NPDES PERMIT MSR10



MISSISSIPPI DEPARTMENT OF  
ENVIRONMENTAL QUALITY

### INSTRUCTIONS

Coverage recipients under Mississippi's Large Construction Storm Water General Permit may temporarily suspend required weekly inspections of erosion and sediment controls and monthly record keeping by submission of this form. Inspections may be suspended only when land disturbing activities have ceased, no further land disturbing activities are planned for a period of at least six (6) months, the site is stable with no active erosion, and vegetative cover has been established (see ACT9, S-1). The coverage recipient is responsible for all permit conditions during the suspension period and nothing in this condition shall limit the rights of MDEQ to take enforcement or other actions against the coverage recipient. Once land disturbing activities resume MDEQ must be notified and all inspections and record keeping required by the permit must also resume. Color photographs, representative of the construction site, must be submitted with this inspection form.

### COVERAGE RECIPIENT INFORMATION

COVERAGE RECIPIENT CONTACT PERSON: \_\_\_\_\_

COMPANY NAME: \_\_\_\_\_

STREET OR P.O. BOX: \_\_\_\_\_

CITY: \_\_\_\_\_ STATE: \_\_\_\_\_ ZIP: \_\_\_\_\_

PHONE # (INCLUDE AREA CODE): \_\_\_\_\_ E-MAIL: \_\_\_\_\_

### PROJECT INFORMATION

CONSTRUCTION STORM WATER GENERAL PERMIT COVERAGE NUMBER: **MSR10** \_\_\_\_\_

PROJECT NAME: \_\_\_\_\_

CITY: \_\_\_\_\_ COUNTY: \_\_\_\_\_

I certify under penalty of law that this document and all attachments were prepared under my direction or supervision in accordance with a system designed to assure that qualified personnel properly gathered and evaluated the information submitted. Based on my inquiry of the person or persons who manage the system, or those persons directly responsible for gathering the information, the information submitted is, to the best of my knowledge and belief, true, accurate and complete. I am aware that there are significant penalties for submitting false information, including the possibility of fine and imprisonment for knowing violations. **I further certify that: land disturbing activities have ceased, no further land disturbing activities are planned for a period of at least six (6) months, the site is stable with no active erosion, and vegetative cover has been established.**

\_\_\_\_\_  
Signature (must be signed by coverage recipient)

\_\_\_\_\_  
Date Signed

\_\_\_\_\_  
Printed Name

\_\_\_\_\_  
Title

Please submit this form to:

Chief, Environmental Permits Division  
MS Department of Environmental Quality, Office of Pollution Control  
P.O. Box 2261  
Jackson, Mississippi 39225

# Request for Termination (RFT) of Coverage



**LARGE CONSTRUCTION GENERAL PERMIT**  
**Coverage No. MSR10** \_\_\_\_\_ **County** \_\_\_\_\_  
(Fill in your Certificate of Coverage Number and County)

**This form must be submitted within thirty (30) days of achieving final stabilization (see ACT10, S-1 of general permit). Failure to submit this form is a violation of permit conditions.**

**The signatory of this form must be the owner or operator (prime contractor) who is the current coverage recipient (rather than the project manager or environmental consultant).**

(Please Print or Type)

**Project Name:** \_\_\_\_\_

**Physical Site Street Address (if not available, indicate nearest named road):** \_\_\_\_\_

**City:** \_\_\_\_\_ **County:** \_\_\_\_\_ **Zip:** \_\_\_\_\_

**Coverage Recipient Company Name:** \_\_\_\_\_

**Street Address / P.O. Box:** \_\_\_\_\_

**City:** \_\_\_\_\_ **State:** \_\_\_\_\_ **Zip:** \_\_\_\_\_

**Coverage Recipient Contact Name and Position:** \_\_\_\_\_ **Tel. #:** (\_\_\_\_) \_\_\_\_\_

**Has another owner(s) or operator(s) assumed control over all areas of the site that have not reached final stabilization?**

**RESIDENTIAL SUBDIVISIONS:**

- YES. A copy of the Registration Form for Residential Lot Coverage for each lot or out parcel that has been sold and a site map, indicating which lots have been sold, are attached.**
- NO. Coverage may not be terminated until all areas have reached final stabilization.**

**COMMERCIAL DEVELOPMENT:**

- YES. A copy of the site map, indicating which out-parcels have been sold, is attached.**
- NO. Coverage may not be terminated until all areas have reached final stabilization.**

I certify under penalty of law that this document and all attachments were prepared under my direction or supervision in accordance with a system designed to assure that qualified personnel properly gathered and evaluated the information submitted. Based on my inquiry of the person or persons who manage the system, or those persons directly responsible for gathering the information, the information submitted is, to the best of my knowledge and belief, true, accurate and complete. I am aware that there are significant penalties for submitting false information, including the possibility of fines and imprisonment for knowing violations. I understand that by submitting this Request for Termination and receiving written confirmation, I will no longer be authorized to discharge storm water associated with construction activity under this general permit. Discharging pollutants associated with construction activity to waters of the State without proper permit coverage is a violation of state law. I also understand that the submittal of this Request for Termination does not release an owner or operator from liability for any violations of this permit or the Clean Water Act.

\_\_\_\_\_  
Authorized Name (Print) Telephone Signature Date Signed

<sup>1</sup>This application shall be signed according to the General Permit, ACT11, T-7 as follows:

- For a corporation, by a responsible corporate officer.
- For a partnership, by a general partner.
- For a sole proprietorship, by the proprietor.
- For a municipal, state or other public facility, by principal executive officer, mayor, or ranking elected official.

After signing please mail to: Chief, Environmental Permits Division  
MS Department of Environmental Quality, Office of Pollution Control  
P.O. Box 2261  
Jackson, Mississippi 39225

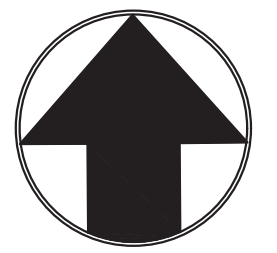
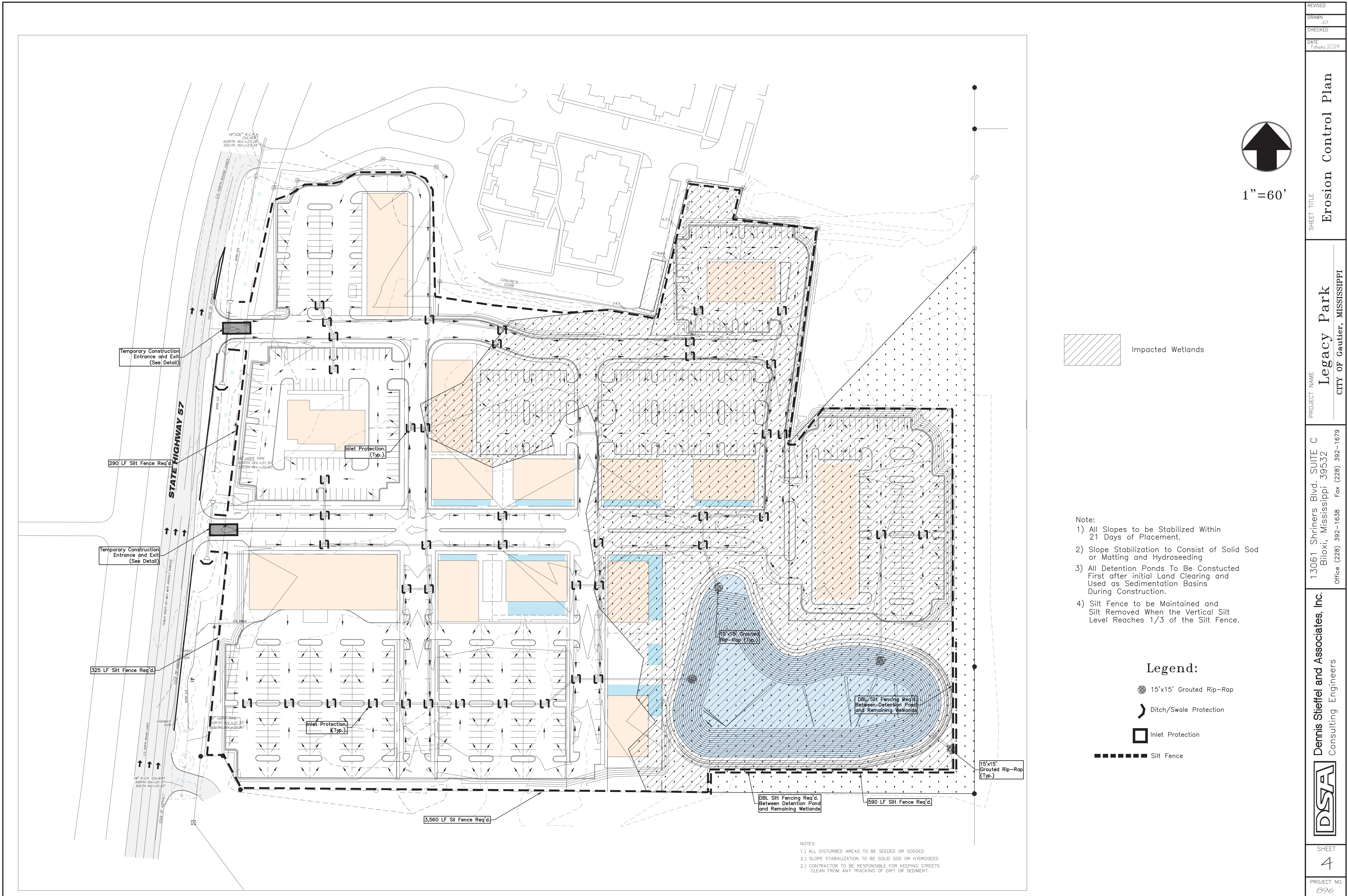





1" = 60'

 Impacted Wetlands

- Note:
- 1) All Slopes to be Stabilized Within 21 Days of Placement.
  - 2) Slope Stabilization to Consist of Solid Sod or Matting and Hydroseeding
  - 3) All Detention Ponds To Be Constructed First after initial Land Clearing and Used as Sedimentation Basins During Construction.
  - 4) Silt Fence to be Maintained and Silt Removed When the Vertical Silt Level Reaches 1/3 of the Silt Fence.

**Legend:**

-  15'x15' Grouted Rip-Rap
-  Ditch/Swale Protection
-  Inlet Protection
-  Silt Fence

NOTES:  
 1.) ALL DISTURBED AREAS TO BE SEEDED OR SODDED  
 2.) SLOPE STABILIZATION TO BE SOLID SOD OR HYDROSEED  
 3.) CONTRACTOR TO BE RESPONSIBLE FOR KEEPING STREETS CLEAN FROM ANY TRACKING OF DIRT OR SEDIMENT.

REVISED	<p><b>Erosion Control Plan</b></p>
DRAWN LH	
CHECKED	
DATE February 2024	
SHEET TITLE	<p><b>Legacy Park</b> CITY OF GAULTIER, MISSISSIPPI</p>
PROJECT NAME	
PROJECT NO.	<p>13061 Shriners Blvd. SUITE C Biloxi, Mississippi 39532 Office (228) 392-1638 Fax (228) 392-1679</p>
CONSULTING ENGINEERS	<p><b>DSA</b> Dennis Stieffel and Associates, Inc. Consulting Engineers</p>
SHEET	<p>4</p>
PROJECT NO.	<p>896</p>

**STORM WATER POLLUTION PREVENTION PLAN**

**MAINTENANCE PLAN:**

- 1) Vegetative buffer zones shall be maintained between land disturbing activities and perennial water bodies or planted vegetated areas. Buffer zones shall provide a minimum 150-ft buffer and shall be no less than 15 feet in width.
- 2) Vegetative controls shall be initiated no later than the next work day following any clearing, grading, excavating or other land disturbing activities which have temporarily or permanently ceased on any portion of the site and will not resume for a period of fourteen (14) days or more. Vegetative controls shall consist of Bermuda grass or other suitable ground cover grasses which will blend with the native vegetation and provide the desired stabilization and erosion protection. Solid sod may be used in areas prone to erosion due to isolated concentrations of surface drainage.
- 3) Structural controls shall consist of silt fencing, straw bales, rip-rap and/or erosion matting or some combination thereof at all points of discharge into existing drainage systems. The controls are to be left in place and maintained for the duration of the project. Upon satisfactory stabilization of site, structural controls shall be removed along with any and all silt build-up. Structural controls are to eliminate tracking of sediment in order to prevent any damage to the downstream tributaries or water ways and/or associated wetland areas. Best management practices (BMPs) will be utilized throughout the duration of the construction of the project. Stone-stabilized construction entrances (6" thick and 50' long) will be used to prevent sediment from being tracked onto public roads with tires being washed on an as-needed basis.
- 4) Inspection of all disturbed areas, erosion, sediment controls and outfalls/discharge points are required after rain events that produce a discharge and at least weekly for a minimum of four (4) inspections per month. Make needed repairs within 24 hours. All accumulated sediment shall be removed from structural controls when sediment deposits reach 1/3 to 1/2 the height of the control. For sediment basins, accumulated sediment shall be removed when the capacity has been reduced by 50%. Replace non-functional silt fence. Maintain all vegetated areas to provide proper ground cover and re-grass, fertilize and mulch as needed. Any silt removed shall be disposed of in nonwetland areas.
- 5) Topsoil shall be stockpiled and reapplied to disturbed areas at a depth of 2 inches on 3:1 slopes and 4 inches on flatter slopes with an admixture of commercial grade 13-13-13 fertilizer.
- 6) Heavy equipment use shall be avoided in re-grassed areas. If compaction cannot be avoided, the top 4 inches of the soil bed shall be tilled/scarified before re-vegetation. Any necessary fertilizer or other soil amendments shall be added during the tilling process.
- 7) Steep slopes that cannot be avoided shall have silt fences for all down slope boundaries (and for those side slope boundaries deemed appropriate by individual site conditions) with the exception of those areas incorporating sediment basins with a calculated volume of run-off from a 2-yr, 24-hr storm or 3,600 cubic feet of storage per acre drained as per the Erosion Control & Drainage Plan. Silt fencing shall be installed at the downstream boundaries of the proposed project to protect areas that are to remain undisturbed.
- 8) The following measures shall be implemented to maintain an acceptable TMDL and to prevent fecal coliform and/or pathogens from escaping the project site: a) all storm drain inlets that could potentially receive storm water from construction activities shall be protected by surrounding with silt fence until final stabilization (70% min.); b) the lower orifice in the outlet structure shall be temporarily plugged until the completion of the construction of the project; c) all sedimentation basin outfalls to have triple layers of silt fence installed and d) all wastewater shall be centralized collection and treatment.
- 9) Maintenance of site and all erosion controls will be the Contractor's responsibility during construction and the Home Owner's Association (HOA) post construction with the Municipality having perpetual right of access via easements for emergency purposes.

**SEQUENCE OF CONSTRUCTION ACTIVITIES:**

- 1) Silt fencing structural controls to be installed prior to any land disturbing activities taking place.
- 2) Construct construction entrance(s).
- 3) Construct sedimentation/detention basin(s) with appropriate grassing and/or rip-rap.
- 4) Rough grade site, construct diversions and drainage ways, stockpile topsoil and install silt fence around stockpile, install utilities, culverts and inlets with associated silt fencing.
- 5) Install vegetative controls.
- 6) Construct roadways, drives, parking and buildings.
- 7) Perform final grading, grassing and landscaping operations.
- 8) After site is stabilized, remove all temporary measures and any excess sedimentation from basins.

**HOUSEKEEPING PRACTICES:** All equipment maintenance and repair shall be done off-site. The site is to be cleaned of trash and construction debris on a weekly basis so as to prevent the spreading of such onto adjacent properties. Paints, solvents, fertilizers, and any other potentially toxic materials shall not be stored on site. Portable sanitary facilities will be provided for construction workers. A designated pit area is required near construction entrance(s) for concrete truck wash-out. Site shall be inspected weekly for spills and leaks. Any spills or leaks detected will be immediately cleaned with a dry absorbent material and absorbent oil socks shall be placed around any adjacent drainage inlets. Where sediment has been tracked-out from the site onto paved roads, sidewalks, or other paved areas outside the site, remove deposited sediment "immediately" by the end of the next workday. Remove the track-out by sweeping, shoveling, or vacuuming these surfaces, or by similarly effective means of sediment removal. Upon completion of construction, excessive sedimentation and/or pollutants shall be removed from roadways and sedimentation basins. Emergency spill kit and telephone shall be available for use for site. Any spills in danger of migrating off-site shall be immediately reported to the National Response Center at (800) 424-8802.

**POST CONSTRUCTION/STORM WATER MANAGEMENT MEASURES:** The individual lot/site protection plan consists of the installation of sedimentation/detention basin(s), silt fencing, straw bales and/or other erosion/siltation control measures in a continuous band across the downhill side of all disturbed areas including areas adjacent to streets. Under no circumstances will silt laden run-off be allowed to escape the site. Additionally, these requirements are to be an integral part of any sales contracts and recorded covenants for the development. Sedimentation/detention basin(s) are to be thoroughly cleaned of excess sediment after construction. Grassing and/or rip-rap will be placed at concentrated storm water discharge points to prevent erosion from high run-off velocities.

**TRAINING DOCUMENTATION:** Training records shall include employee's name, worker identification number, date of training, contents of training, an indication whether it was initial or refresher training and the employee's signature acknowledging that training was received. All personnel training associated with this general permit shall be documented on the Employee Training Log Form (see MDEQ Storm Water Permit/LCNOI section in Contract Documents). Completed forms and supporting training documentation shall be maintained on-site with the SWPPP and made available to MDEQ personnel for inspection upon request.

**TRAINING REQUIREMENTS:** A program shall be developed and implemented for initial and periodic refresher training of personnel that are responsible for implementing and/or complying with the requirements of this permit. Initial training for all personnel that are responsible for implementing and/or complying with the requirements of this permit shall be performed within twelve (12) months of issuance of coverage or recovery under this permit. Newly hired employees responsible for implementing and/or complying with the requirements of this permit shall receive initial training prior to performing such responsibilities. All employees responsible for implementing and/or complying with the requirements of this permit shall receive refresher training by December 31st of each calendar year. Training shall at a minimum address, but not be limited to, the following elements:

- (1) SWPPP goals and plan components including:
  - (A) Housekeeping and pollution prevention requirements
  - (B) Spill prevention and response procedures
  - (C) Identification and elimination of non-allowable, non-storm water discharges
  - (D) Installation, maintenance and inspection of erosion and sediment controls for construction activities
  - (E) Installation, maintenance and inspection of BMPs for post-construction storm water
- (2) Procedures for monitoring compliance with non-numeric and numeric limitations
- (3) Recordkeeping, reporting and record retention (3 years min.) requirements (includes understanding the records filing system and being able to produce the required permit documentation during an MDEQ on-site inspection)
- (4) Release reporting and non-compliance notification and reporting requirements
- (5) Applicable standard requirements

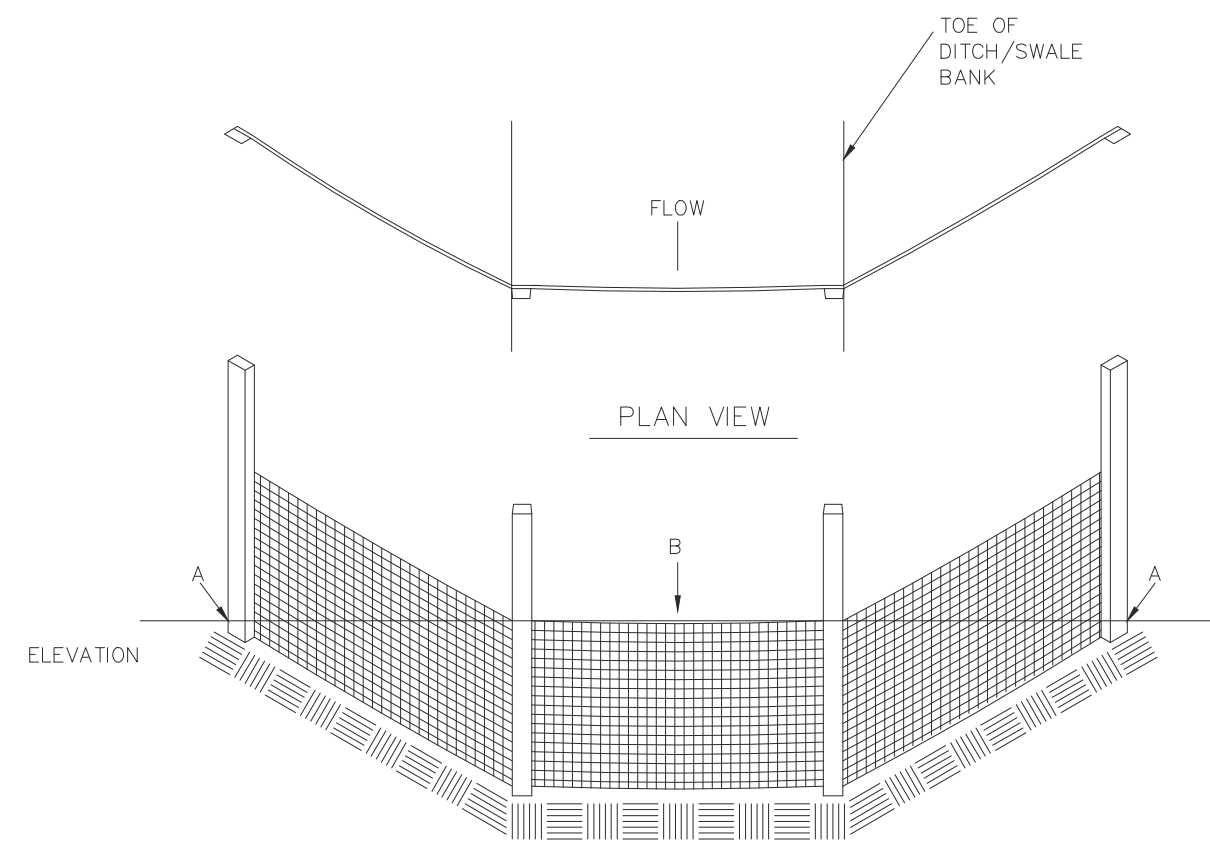

POINTS A SHOULD BE HIGHER THAN POINT B  
**SILT FENCE DITCH/SWALE PROTECTION**

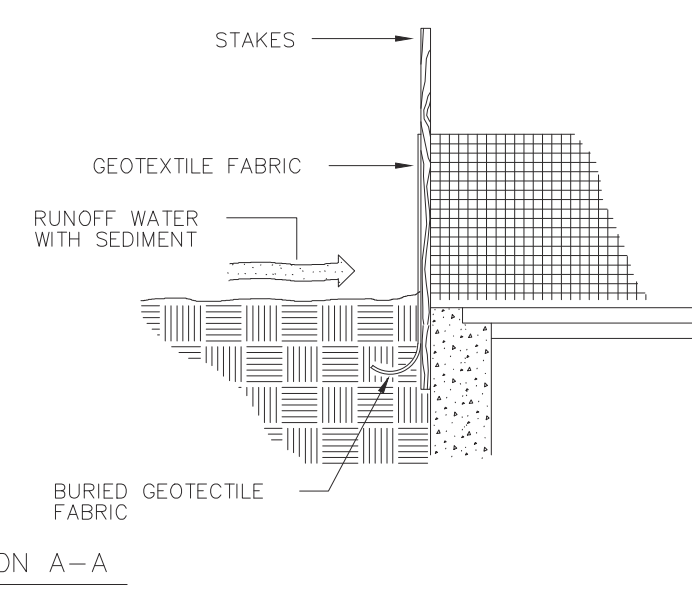

SECTION A-A

FALL OF DITCH (%)	DISTANCE* (ft)
0 - 1	100'
1 - 2	50'
>2	25'

**MIN. DISTANCES FOR EROSION CHECKS**

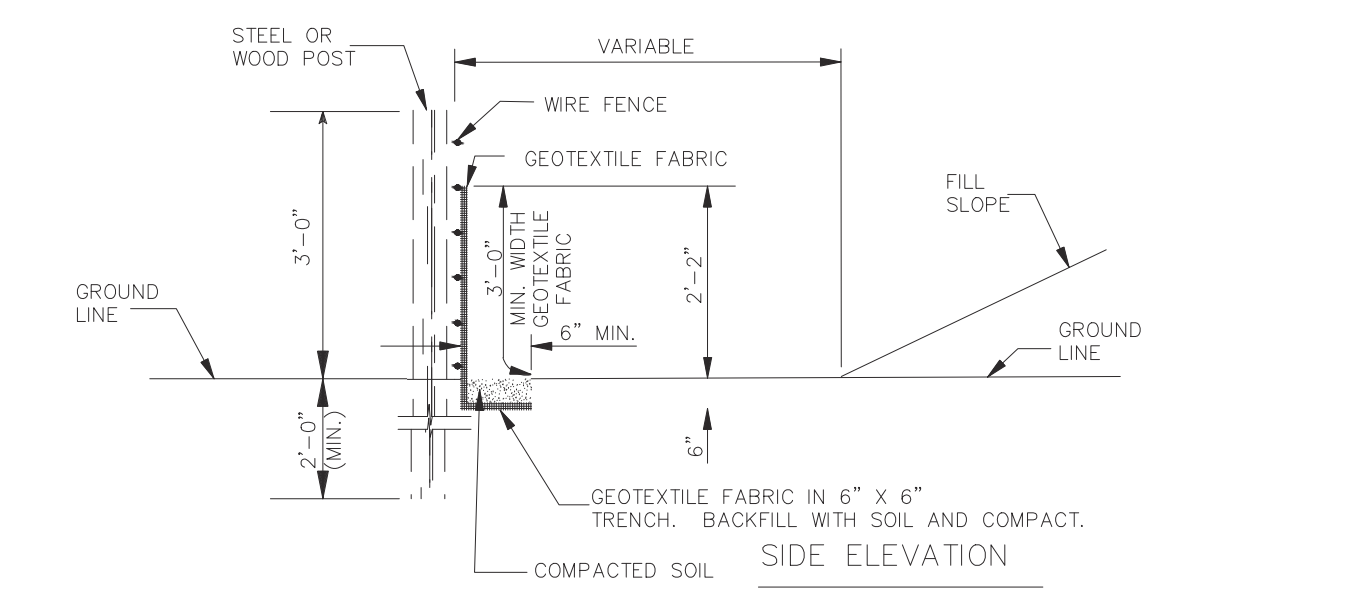
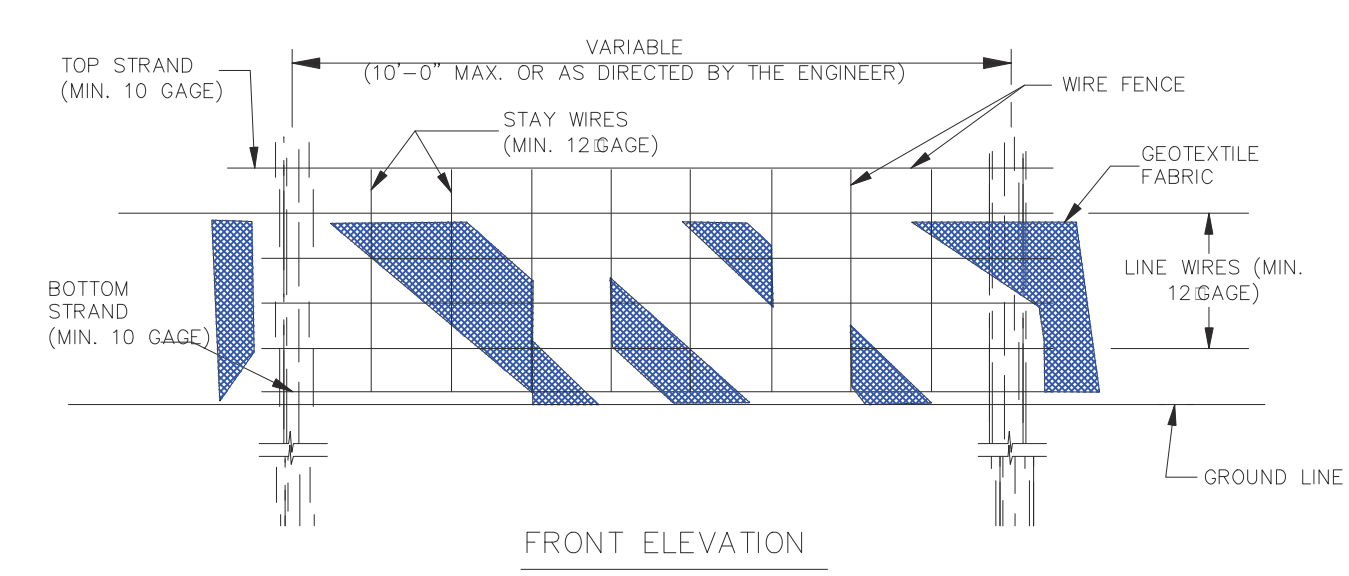
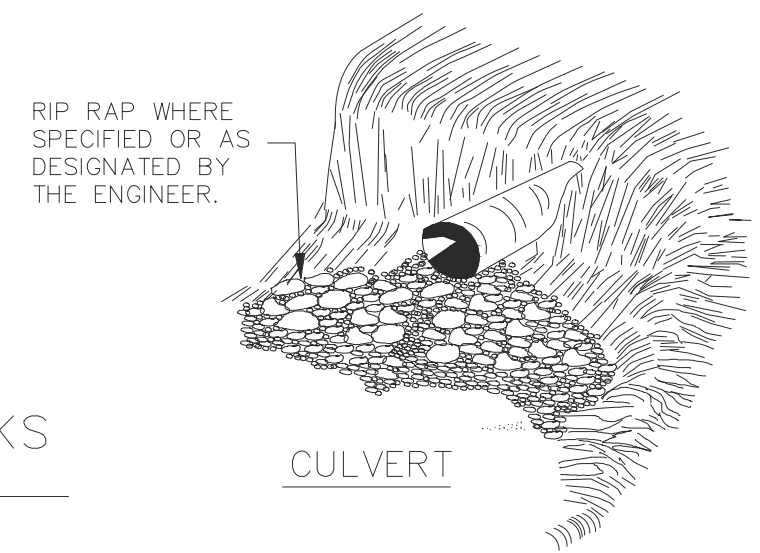

**TEMPORARY SILT FENCING**

**GENERAL NOTES:**

1. EROSION CONTROL SEQUENCE SHALL BE AS FOLLOWS:
  - (A) SILT FENCING TO PROTECT EXISTING WETLANDS SHALL BE INSTALLED
  - (B) DETENTION POND TO BE CONSTRUCTED
  - (C) SILT FENCING AND HAY BALES TO BE INSTALLED AROUND ALL DRAINAGE STRUCTURES
  - (D) APPROPRIATE EROSION CONTROL STEPS TAKEN TO STABILIZE SIDE SLOPES AND SWALES
  - (E) ALL DISTURBED AREAS TO BE GRASSED EXCEPT WHERE SOODING IS REQUIRED
2. CONTRACTOR SHALL BE RESPONSIBLE FOR THE IMPLEMENTATION OF ALL EROSION CONTROL MEASURES IN ACCORDANCE TO THE MISSISSIPPI PERMIT NUMBER: SSM-2011-1271-TMC, AND THE D.E.Q. (SWPP) PERMIT NUMBER ----- "SEE CONTRACT DOCUMENTS FOR COPIES OF PERMITS"
3. CONTRACTOR SHALL INSPECT THE INSTALLED EROSION CONTROL ITEMS AT LEAST ONCE EVERY SEVEN-CALNDAR DAY AND PROVIDE ANY MAINTENANCE REQUIRED TO PREVENT EROSION AND ADVERSE IMPACTS TO RECEIVING STREAMS
4. ENTIRE SITE SHALL BE CLEARED AND GRUBBED UNLESS OTHERWISE NOTED, HOWEVER SPECIAL CARE SHOULD BE TAKEN TO PROTECT ANY ORNAMENTAL TREES THAT COULD REMAIN WITH-IN THIS PROJECT.

**SILT FENCE NOTES:**

1. WIRE SHALL BE MINIMUM OF 32" IN WIDTH AND SHALL HAVE A MINIMUM OF 6 LINE WIRES WITH 12" STAY SPACING.
2. GEOTEXTILE FABRIC SHALL BE A MINIMUM OF 36" IN WIDTH AND SHALL BE FASTENED ADEQUATELY TO THE WIRE AS DIRECTED BY THE ENGINEER.
3. STEEL POST SHALL BE 5'-0" IN HEIGHT AND OF THE SELF-FASTENER ANGLE STEEL TYPE. WOOD POST SHALL BE A MINIMUM OF 5'-0" IN HEIGHT AND 3" OR MORE IN DIAMETER. WIRE FENCE SHALL BE FASTENED TO WOODEN POST WITH NOT LESS THAN 9 GAGE WIRE STAPLES 1" LONG.
4. GEOTEXTILE FABRIC MEETING THE TYPE II MATERIAL REQUIREMENTS AND INSTALLED ACCORDING TO SPECIFICATIONS MAY BE USED WITHOUT WIRE FENCE.
5. SILT FENCE TO BE MAINTAINED AND SILT REMOVED WHEN THE VERTICAL SILT LEVEL REACHES 1/3 OF THE SILT FENCE HEIGHT

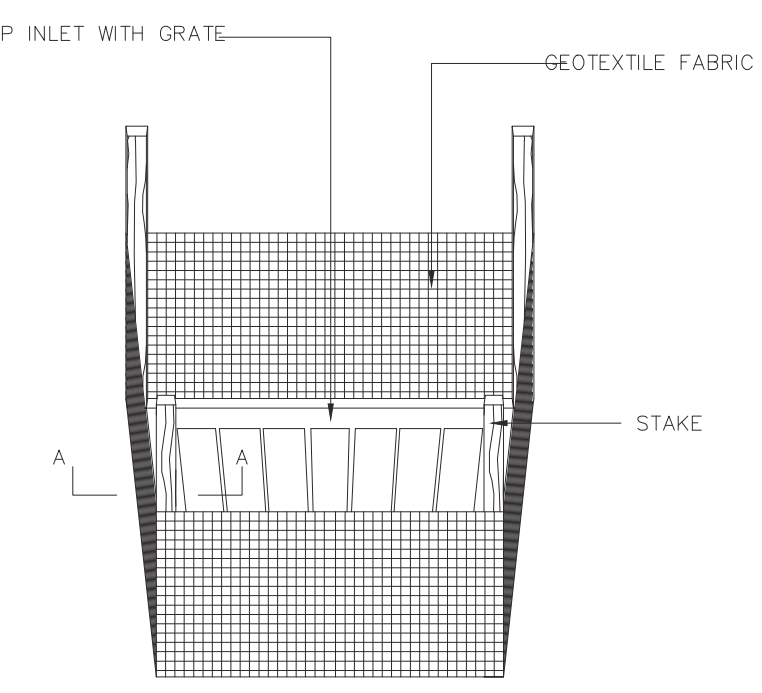

**SILT FENCE INLET PROTECTION**

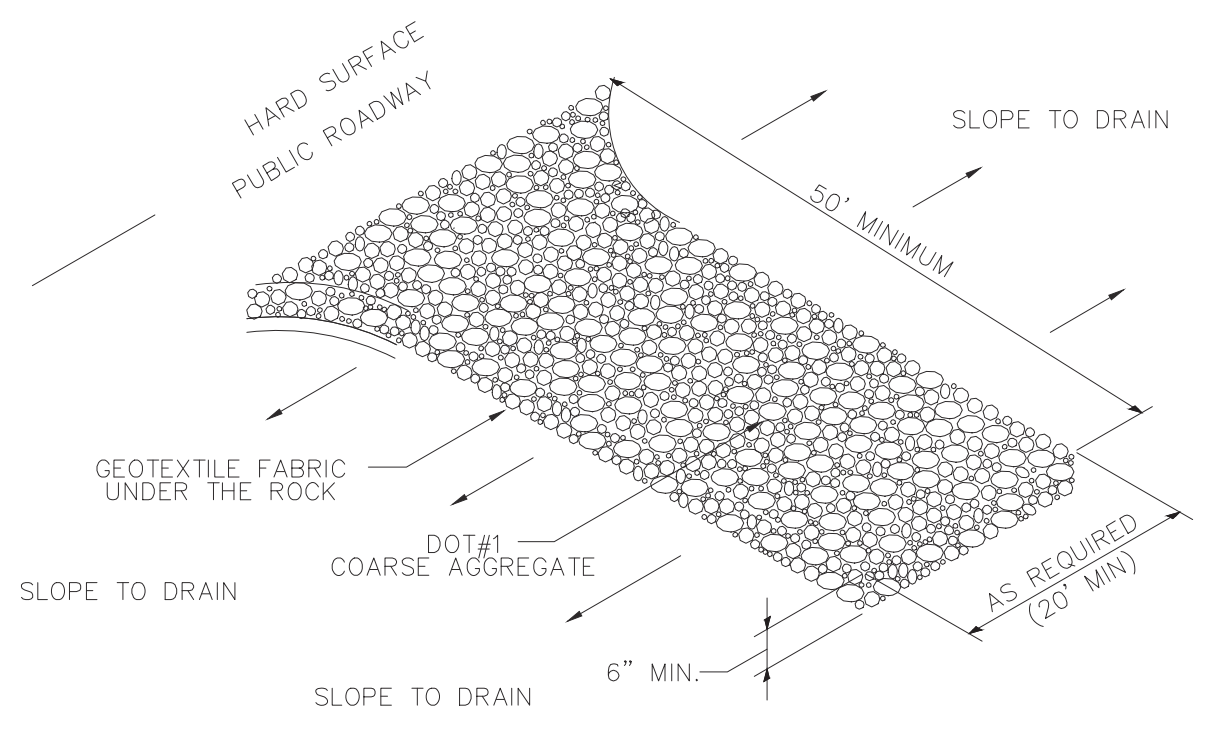

**TEMPORARY CONSTRUCTION ENTRANCE AND EXIT**  
SCALE: N.T.S. UPDATED: 4/5/05

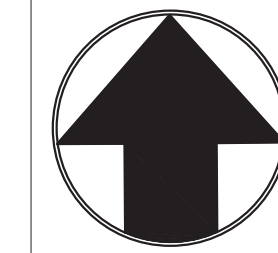
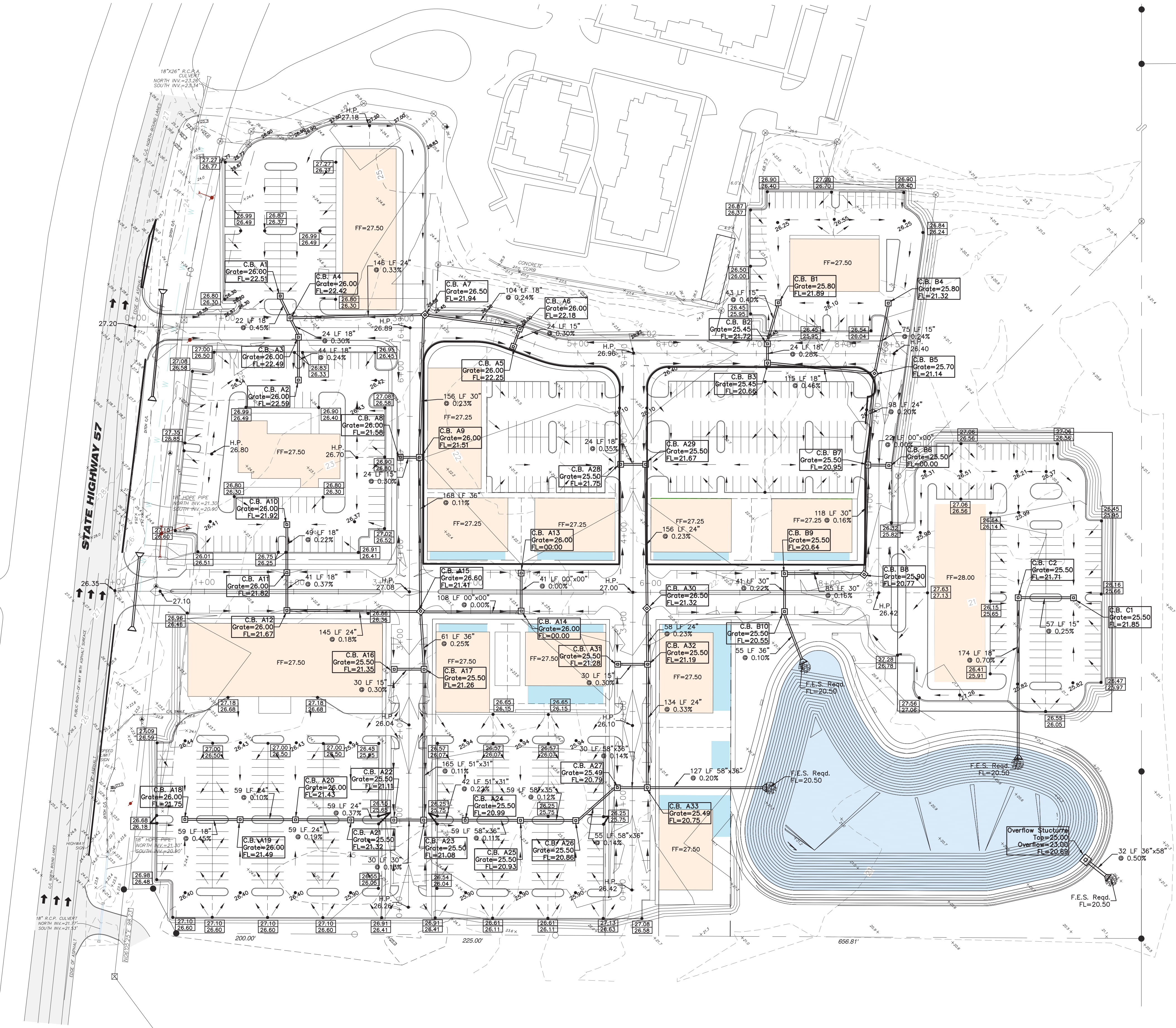

1"=60'

REVISION	PROJECT NAME	PROJECT NO.
DRAWN	13061 Shriners Blvd., SUITE C	896
CHECKED	Biloxi, Mississippi 39532	
DATE	Office (228) 392-1638 Fax (228) 392-1679	
January 2024		
SHEET TITLE	Legacy Park	
	CITY OF GAULTIER, MISSISSIPPI	
	Drainage Plan	
	Dennis Stieffel and Associates, Inc.	
	Consulting Engineers	

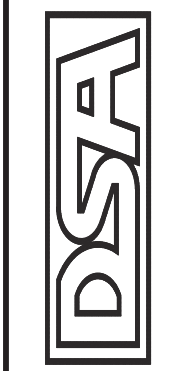

SHEET  
6

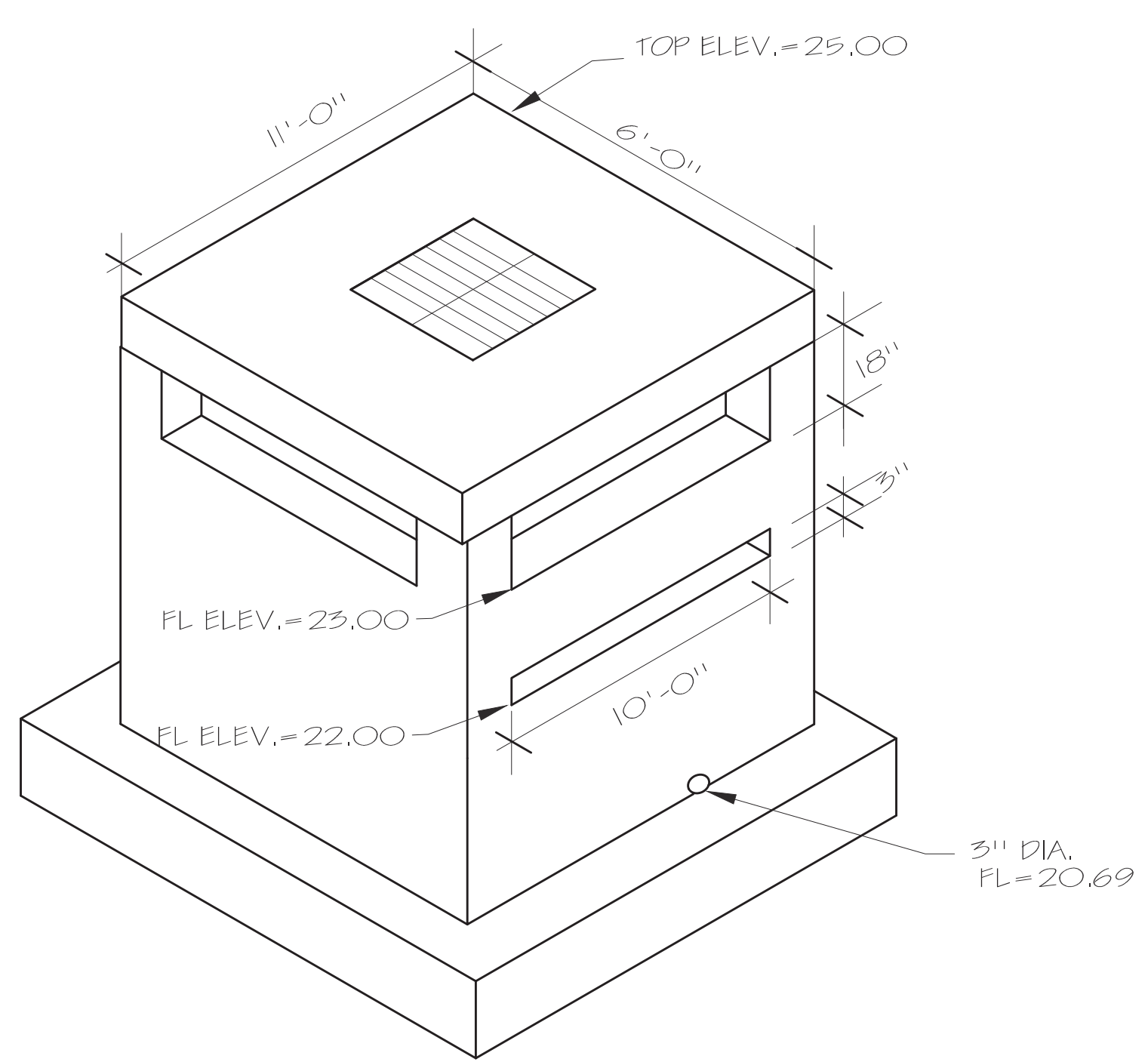
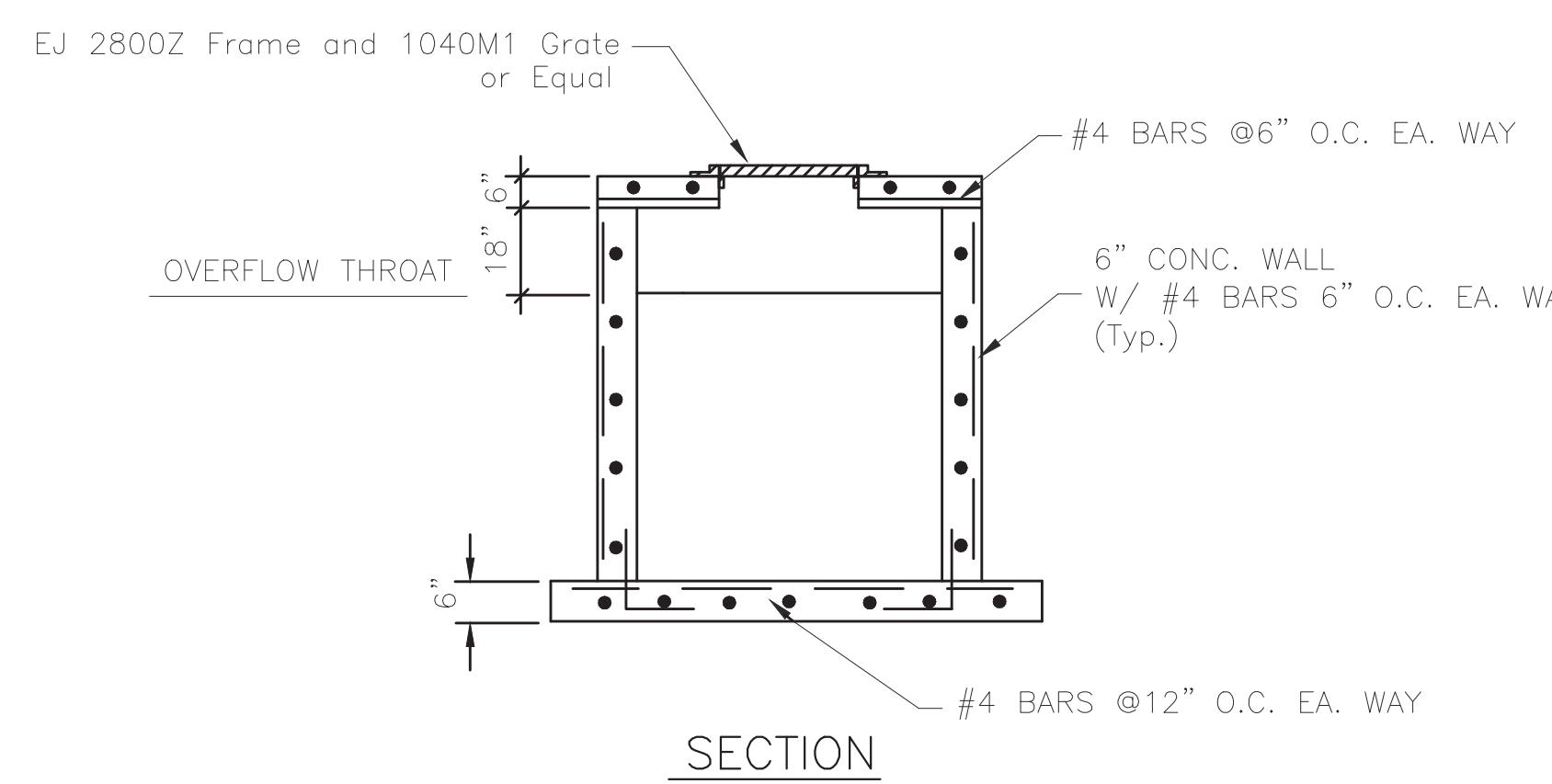
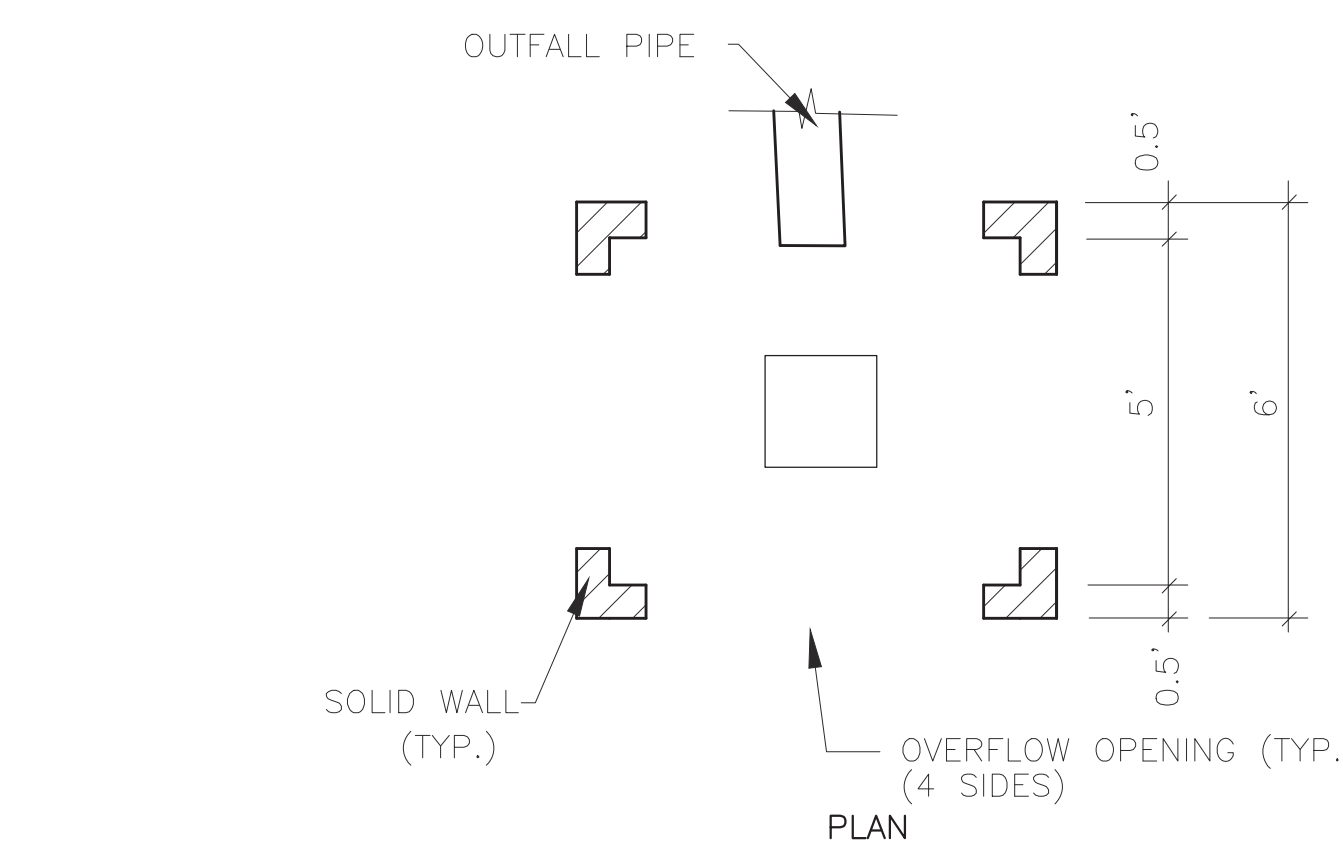

OVERFLOW STRUCTURE  
N.T.S.

NOTE:  
 OVERFLOW BOX TO BE CONSTRUCTED WITH THE SAME MIN. DIMENSIONS NOTED ON THE CATCH BASIN DETAILS EXCEPT WHERE OTHERWISE SPECIFIED.

OVERFLOW WEIR DETAIL  
N.T.S.

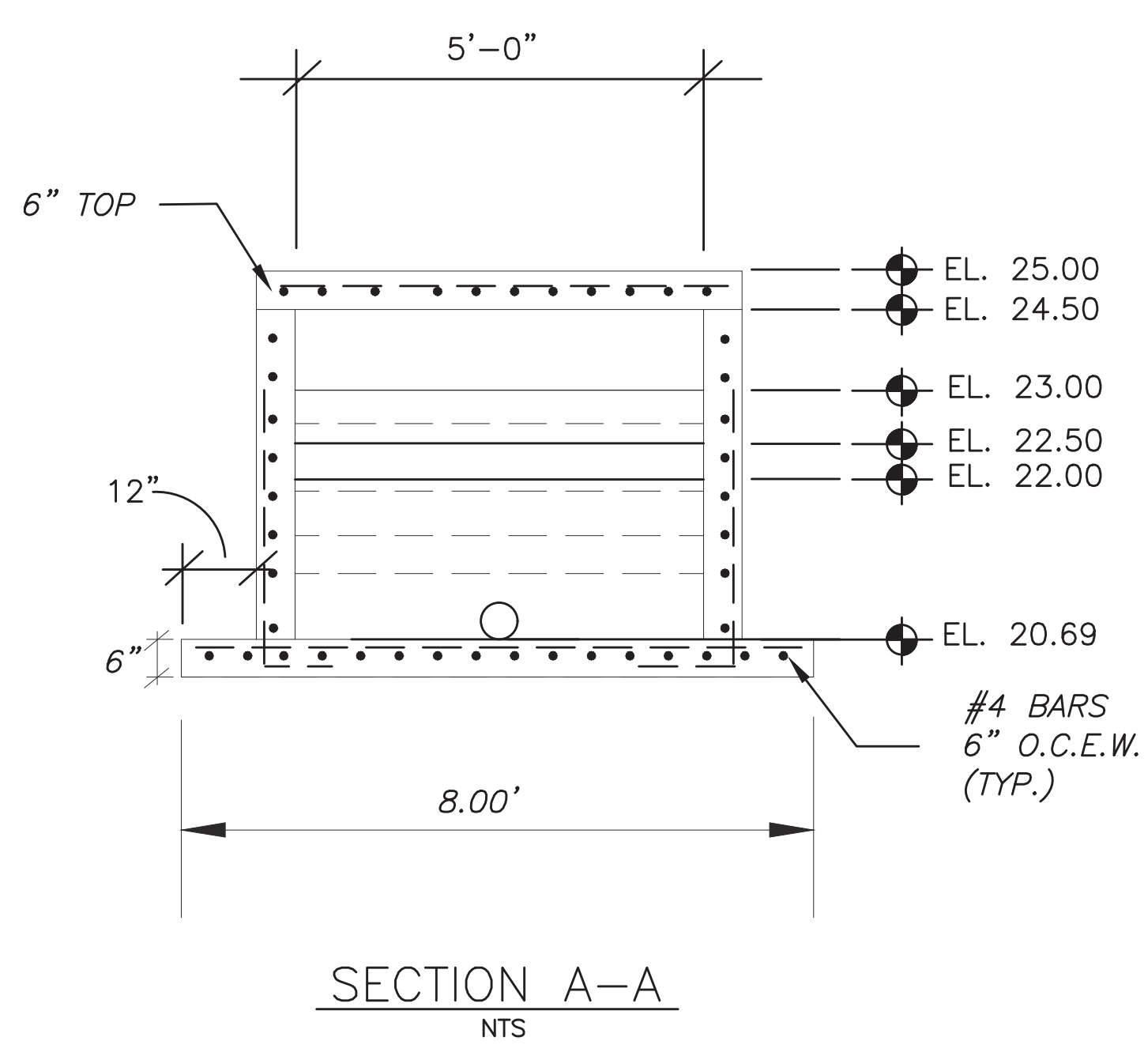

SECTION A-A  
N.T.S.

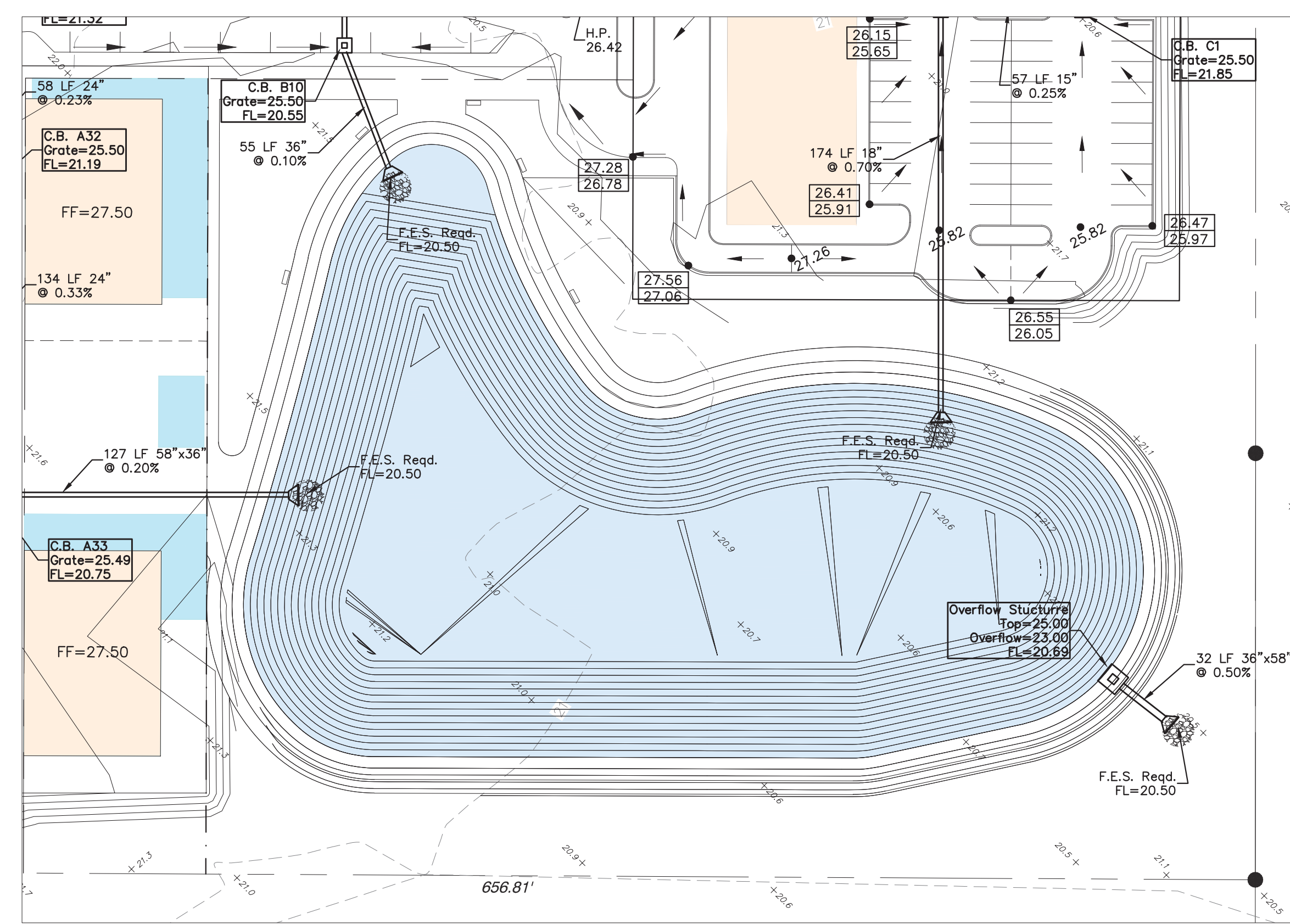

Site Plan

Basin	TOB	TOS	BOS	BOB	Skimmer Size (in)	Skimmer Capacity (cf/48 hrs)	Drainage Area (ac)	Avg Surf Area (sf)	Storage Depth (ft)	Volume Req'd (cf)	Volume Provided (cf)	
C3	25.00	23.00	20.69	16.69	5.00	4.50	62,640	17.4	66,200	6.31	62,640	417,722

Note: 3,600 d/cleared-ac volume required for drainage areas greater than 10 acres.

MDEQ WQC Detention Basin Calculations  
 Legacy Medical Center  
 Project No. 896  
 January 31, 2024

Basin	Drainage Area (ac)	Swale Length (avg) (ft)	Units/Basin	Basin Geometrics			Average Surface Area Required (sf)	Average Surface Area Provided (sf)	Basin Vol Req'd (cf)	Basin Vol Provided (cf)	Circular Orifice Dia (in)	Return Time		Top of Bank Elev (ft)	Top of Storage Elev (ft)	Avg Storage Elev (ft)	Bot of Storage Elev (ft)	Bot of Basin Elev (ft)	Rectangular Orifice Top (Elev) (ft)	Rectangular Orifice Bot (Elev) (ft)	Rectangular Orifice Width (ft)	Overflow Structure		Forebay Geometrics								
				1st Half (hrs)	Total (hrs)	Top (Elev) (ft)						Width (ft)	Vol (cf)									L (ft)	W (ft)	D (ft)								
C3	17.4	150	1	266	133	2.31	35,357	66,200	81,675	152,922	3	54	200+	25.00	1.0574	23.00	0.8983	21.85	0.8117	20.69	0.7290	16.69	0.6658	22.00	22.25	10.00	25.00	5.00	16,335	50	50	6.5

Abbreviations:  
 DCO - Diameter of Circular Orifice  
 TOB - Top of Bank  
 TOS - Top of Storage  
 BOS - Bottom of Storage  
 DOS - Depth of Storage  
 BOB - Bottom of Basin  
 TRO - Top of Rectangular Orifice  
 BRO - Bottom of Rectangular Orifice  
 WRO - Width of Rectangular Orifice  
 TOFS - Top of Overflow Structure  
 WOFS - Width of Overflow Structure (inside)

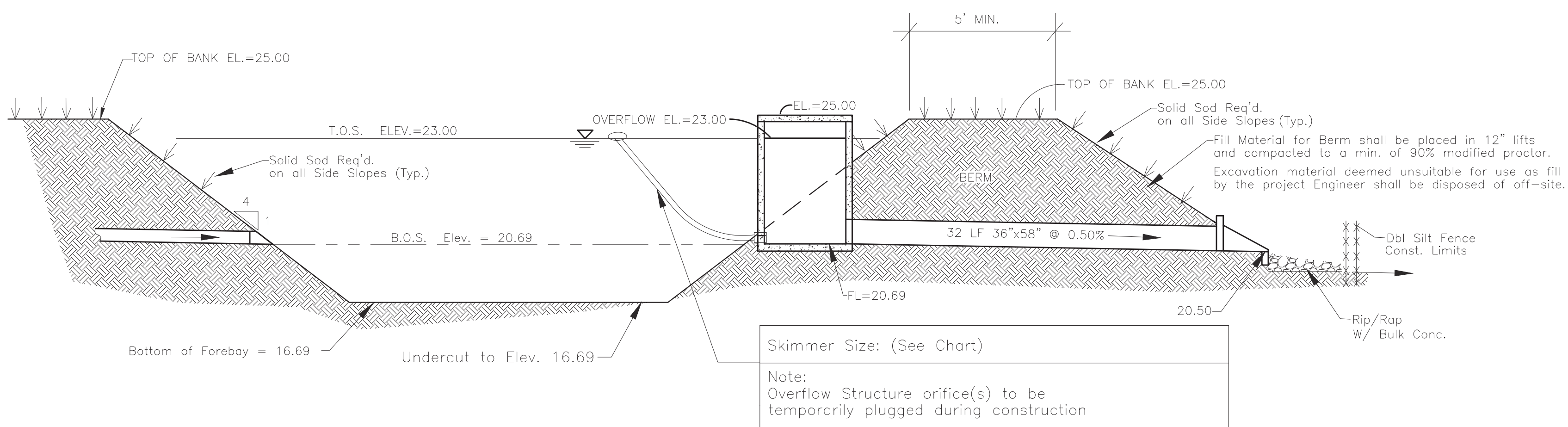

Section of Detention  
N.T.S.

**FOR OPC USE ONLY**  
AI NO. \_\_\_\_\_  
PLA NO. \_\_\_\_\_

**INFORMATION REGARDING PROPOSED WASTEWATER PROJECTS  
TO: THE MISSISSIPPI OFFICE OF POLLUTION CONTROL**

The ATM Holdings, LLC,  
(Insert Name of Body Making Application, i.e., Individual, Corporation, Municipality, etc.)

whose mailing address is 419 East Beach Drive, Ocean Springs, MS, 39564,  
(Street and Number) (City) (State) (Zip)

whose responsible official is Dr. Satjit Adlakha, Member,  
(Name) (Title)

and whose phone number is (228) 282-0977 (cell),

Herewith submits for consideration of the OPC plans, specifications, and other necessary data prepared by

Dennis Stieffel & Associates, P.A., Inc.  
(Engineer or Firm)

Dennis Stieffel  
(Firm's Project Contact Person, if applicable)

13061 Shriners Blvd., Ste C  
(Mailing Address)

Biloxi, MS 39532  
(City, State, Zip)

(228) 392-1638 / (228) 860-8161 (cell)  
(Phone Number)

who is hereby authorized to represent the application in the engineering features of this project for the construction of 2,800 linear feet of new gravity sewer main connected to the existing municipal system.

(Clearly Describe Project: New System, Modification, Extension, Rehabilitation, Treatment, etc.)

to serve Legacy Medical Park Subdivision (9 lots)  
(Subdivision, Plant, School, Other)

located at northeast corner of Hwy 57 & Hwy 90; Section 30, T7S, R7W  
(Approximate Location, Including Section Township, and Range)

in or near the City of Gautier in the County of Jackson, State of

Mississippi, as required by the regulations of the OPC and herewith make application to the OPC for the approval of this project. We understand through the regulations of the OPC that this approval is required prior to the initiation of construction activities.

Upon construction, these facilities will be owned and maintained by City of Gautier

\_\_\_\_\_  
(Name of Utility Company, Municipality, Owner, Developer, etc.)

whose mailing address is P. O. Box 670, Gautier, MS, 39553,  
(Street and Number) (City) (State) (Zip)

**NOTE: IF THIS PROJECT DOES NOT ADD ANY NEW CONNECTIONS OR ADDITIONAL FLOWS TO THE COLLECTION SYSTEM, YOU MAY OMIT SECTIONS A. THROUGH E. BELOW.**

**A. EXISTING SEWAGE COLLECTION SYSTEM**

1. The facilities collecting the sewage from this proposed project are owned by City of Gautier.  
(Utility Company, Municipality, etc.)
2. Number of connections existing are \_\_\_\_\_.
3. The length of sanitary sewers existing are \_\_\_\_\_.
4. The number of existing lift stations are \_\_\_\_\_.
5. Additional facilities that collect sewage from this proposed project, i.e. a regional wastewater authority, are owned by Jackson County Utility Authority (JCUA).

**B. CERTIFICATION(S) FROM COLLECTION ENTITIES**

The official(s) responsible for the wastewater collection facilities denoted in Section A. above, that will serve the proposed project, do hereby certify that we agree to transport the wastewater flows generated from the proposed project. We also hereby certify that we have determined that our collection system(s) have the capacity available to transport properly the wastewater flows generated from the proposed project.

\_\_\_\_\_  
Signature  
  
\_\_\_\_\_  
Title  
City of Gautier  
Entity

\_\_\_\_\_  
Signature  
Executive Director  
Title  
Jackson County Utility Authority  
Entity



**C. EXISTING SEWAGE TREATMENT WORKS**

1. The facilities responsible for treatment of the sewage from this proposed project are owned by Jackson County Utility Authority (JCUA).  
(Utility Company, Municipality, etc.)
2. The OPC Permit Number for this wastewater facility is MS 0045446 (NPDES).
3. The capacity for this wastewater treatment facility is 7.0 MGD.
4. The treatment type of this wastewater facility is Aerated Lagoon/Constructed Wetlands.  
(Activated Sludge, Aerated Lagoon, etc.)
5. The present population served by treatment facility is 40,000 +/-.
6. The operator in charge will be Brian Davis, who is a Class III wastewater operator, holding certificate number 6321-III.

**D. CERTIFICATION FROM WASTEWATER TREATMENT ENTITY**

The official responsible for the wastewater treatment facility denoted in Section C. above, that will serve the proposed project, does hereby certify that we agree to treat the wastewater flows generated from the proposed project. We also hereby certify that we have determined that our treatment facility has the capacity available to treat properly the wastewater flows generated from the proposed project.

\_\_\_\_\_  
Signature  
Executive Director  
\_\_\_\_\_  
Title  
Jackson County Utility Authority  
Entity

**E. PROPOSED PROJECT DETAILS**

1. The ultimate population to be served by this proposed project is (9)(3.0) = 27.
2. The number of connections to be added are 9.
3. Per capita discharge 75 gpcd: Infiltration 0 gpcd. (Estimate, if unknown)
4. Area Served in Acres 20 Design Population Per Acre (27/20) = 1.4.
5. The area water is supplied by City of Gautier  
\_\_\_\_\_  
(Name and Address of Water Utility)

6. Proposed Sewage Pumping Stations

Location or Number	Units Served	Pump Capacity (gpm)	Influent Flow (gpm)	
			Avg.	Peak
None	0	0	0	0

**F. ADDITIONAL CLEARANCES**

**NOTE: APPROVAL OF THIS PROJECT SHALL NOT BE GRANTED UNTIL ALL THE MDEQ PERMITS, COVERAGES, AND APPROVALS DENOTED BELOW ARE SATISFACTORILY ADDRESSED.**

1. The total area of ground disturbance by clearing, grading, and excavating for utilities, roadways, lots, etc. is 20 acres.
2. For construction projects disturbing five or more acres, have you applied to MDEQ or an MDEQ approved local authority for construction storm water permit coverage?  
 Yes       Not applicable  
 If not applicable, why? \_\_\_\_\_.

**NOTE: IF YOU ARE DISTURBING MORE THAN ONE ACRE BUT LESS THAN FIVE ACRES AFTER MARCH 10, 2003, YOU MUST FOLLOW THE REQUIREMENTS OF MDEQ'S SMALL CONSTRUCTION STORM WATER GENERAL PERMIT. ALSO, AFTER MARCH 10, 2003, IF YOU ARE IN AN AREA THAT HAS AN MDEQ APPROVED LOCAL AUTHORITY YOU MUST APPLY FOR APPROVAL FOR 1-5 ACRE CONSTRUCTION PROJECTS. SOME LOCAL AUTHORITIES MAY REQUIRE APPROVAL FOR DISTURBANCE LESS THAN ONE ACRE.**

3. Have determinations/authorizations been received from the Corps of Engineers regarding the need for a Section 404 Permit, General Permit or Nationwide Permit for stream or intermittent drain crossings, stream re-routing, or for placing fill material into wetlands?  
 Yes       Pending       Not applicable  
 If not applicable, why? \_\_\_\_\_.

**G. ADDITIONAL CERTIFICATIONS**

We hereby certify that we are the applicants for this project, that we are familiar with the information contained in this form, and that, to the best of our knowledge and belief, such information is true, complete, and accurate.

  
\_\_\_\_\_  
Signature of Responsible Official for Body Making Application

Dr. Satjit Adlakha, Member, ATM Holdings, LLC  
Printed Name and Title of Above

I hereby certify that the engineering documents for this project were prepared by myself or under my direct supervision, that I am familiar with the information contained in this form, and that, to the best of my knowledge and belief, such information is true, complete, and accurate.

  
\_\_\_\_\_  
Signature of Engineer Registered Under Mississippi Laws

Dennis Stieffel, P.E. #11420  
Typed Name and Registration Number



(Seal)

**THE APPLICANTS AGREE THAT NO CHANGES IN OR DEVIATION FROM THE PLANS AND SPECIFICATIONS APPROVED BY THE OPC WILL BE MADE EXCEPT WITH THE PRIOR CONSENT AND APPROVAL OF THE OPC.**

COMMENTS: \_\_\_\_\_  
\_\_\_\_\_  
\_\_\_\_\_  
\_\_\_\_\_